

Versatronik® 501 & 501D

LON Communication Gateway



Document Applicable to:

Versatronik 501 NR2/LON P/N 704049
Versatronik 501D NR2/LON P/N 704068

Applicable Controls

Vitocontrol-S, MW1 and MW2
Vitocontrol 300-K, MW1B and MW2B
Vitocontrol 100, GC1/GC1B
Vitocontrol 300, GW2
Vitocontrol 300, GW5B
Vitocontrol 200, HO1
Vitocontrol 200 B2HA

Technical, Installation and Configuration Information

Cautionary Statement

The information presented in this document is only to be used by those familiar with its application and use.



C US LR 102874

IMPORTANT

Read and save these instructions for future reference

About these instructions



Take note of all symbols and notations intended to draw attention to potential hazards or important product information. These include "WARNING", "CAUTION" and "IMPORTANT". See below.

 WARNING
Indicates an imminently hazardous situation which, if not avoided, could result in death, serious injury or substantial product/property damage.

→ *Warnings draw your attention to the presence of potential hazards or important product information.*

 CAUTION
Indicates an imminently hazardous situation which, if not avoided, may result in minor injury or product/property damage.

→ *Cautions draw your attention to the presence of potential hazards or important product information*

 CAUTION
Static sensitive components may be damaged by improper handling or work within the control. Ensure all possible measures are taken to eliminate build-up of static electricity.

IMPORTANT

→ *Helpful hints for installation, operation or maintenance which pertains to the product.*

Trademark Information

Viessmann® and Vitotronic® are trademarks of Viessmann Werke GmbH & Co KG registered in the United States and other countries.

Please visit:

www.viessmann.ca
www.viessmann.us

Echelon®, LON®, LONWORKS®, i.LON®, LNS®, LONMARK®, Neuron®, and the LonUsers logo are trademarks of Echelon Corporation registered in the United States and other countries.

Please visit:

www.echelon.com

Important Regulatory and Installation Requirements

Codes

The installation of this unit must be in accordance with local codes.

→ *Please carefully read this manual prior to attempting installation. Any warranty is null and void if these instructions are not followed.*

All electrical wiring is to be done in accordance with the latest edition of CSA C22,1 Part 1 and/ or local codes. In the U.S. use the National Electrical Code ANSI/NFPA 70.

→ *The completeness and functionality of field-supplied electrical controls and components must be verified by those installing the device*

The installing contractor must comply with the Standard of Controls and Safety Devices for Automatically-fired Boilers, ANSI/ASME CSD-1 where required by the authority having jurisdiction.

Working on the equipment

The installation, adjustment, service and maintenance of this unit must be done by a licensed professional heating contractor or persons who are qualified and experienced in the installation, service, and maintenance of similar products. There are no user serviceable parts on this control.

 **WARNING**

More than one live circuit. See wiring diagram in this manual. Turn off power supply to control and damper/blower before servicing. Contact with live electrical components can result in serious injury or death

Power supply

Install power supply in accordance with the regulation of the authorities having jurisdiction or in absence of such requirements, in accordance with National Codes.

Purpose of Device and Operation

The Versatronik 501 gateway provides a communication translation between applicable controls and DDC systems which are capable of LON communications.

The Versatronik gateway may be either part of a control panel or stand-alone control device.

This page is intentionally left blank

Installation

Mounting Versatronik Gateway—120VAC Unit

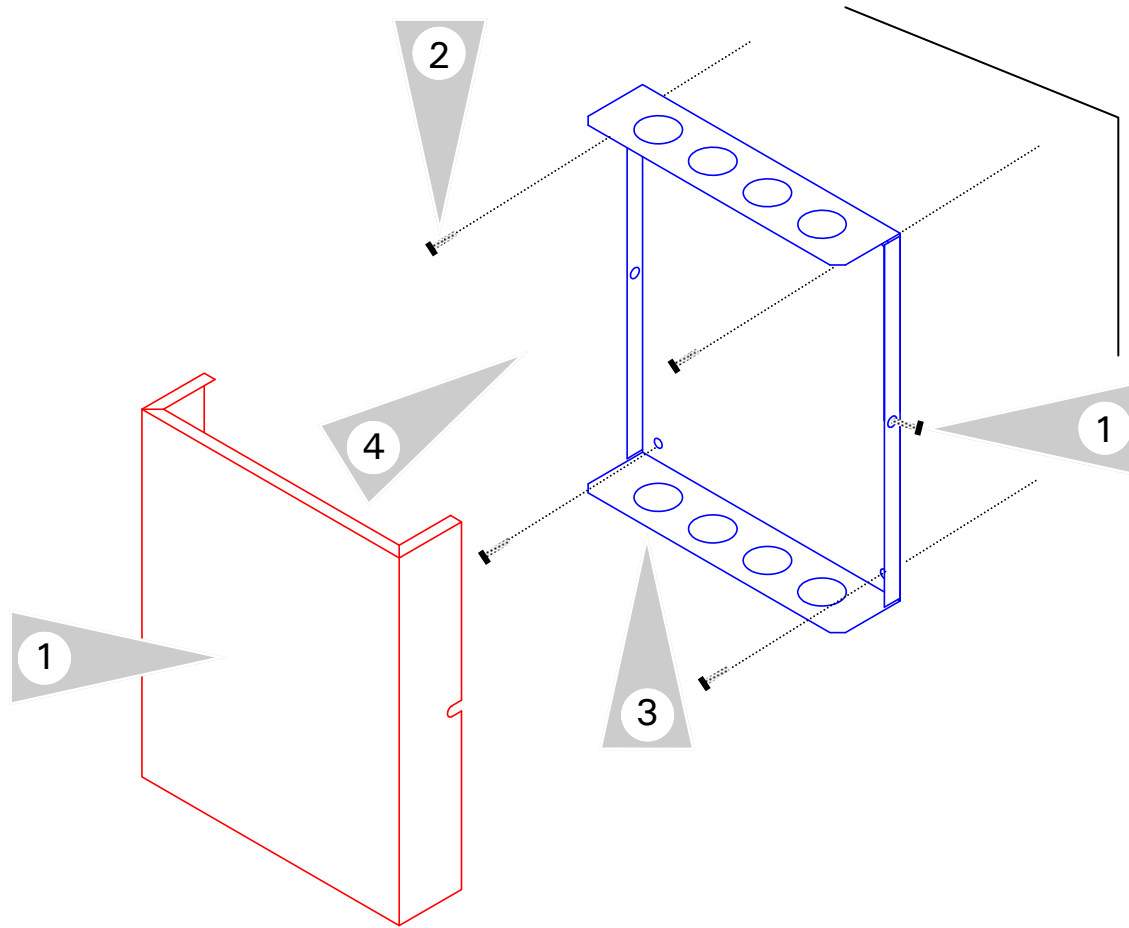

Mounting Steps

1. Mount Versatronik 501 Gateway in a convenient location near the connected boiler controls control. Remove cover by loosening the two screws on either side of base to release the cover.
2. Fasten base to wall using field-supplied screws/fasteners.
3. Remove knockout and installed wire strain relief or box connector. Removal of remaining knockouts is required to make further connections.
4. Once all of the 120VAC and low voltage connections are complete and verified, reinstall the cover from Step 1.



WARNING

When extending wire there is the possibility of exposure to electromagnetic interference. Avoid running wires beside or near high voltage 120/240 VAC conductors. If proximity to high voltage conductors cannot be avoided, use stranded, twisted pair of shield design wire. Ensure that only one end of the shielding is grounded.

Installation

Mounting Versatronik Gateway—24VAC DIN Rail Unit

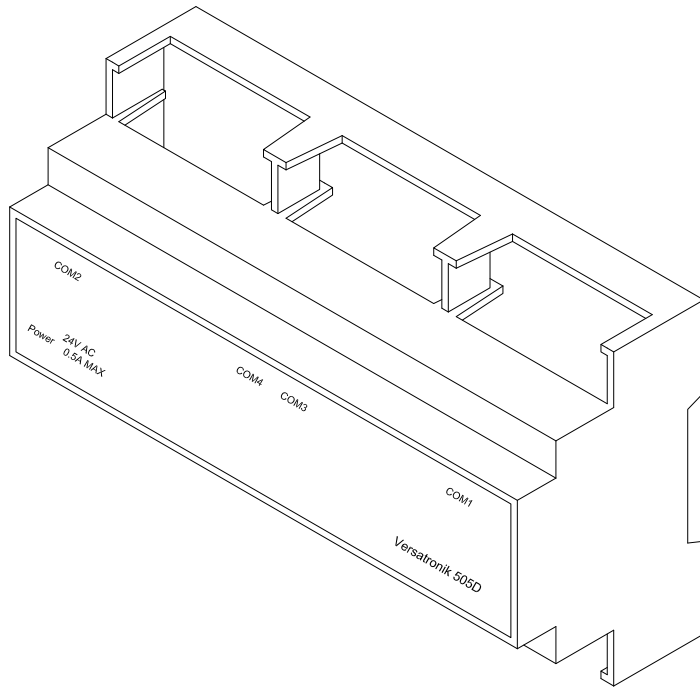

Mounting Steps

1. Mount Versatronik 501D Gateway onto DIN rail within an enclosure in a convenient location near the boiler controls.
2. Make all the necessary connections including the field-supplied 24VAC power connection.

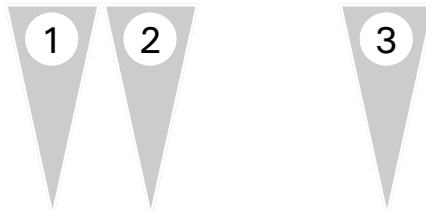

Connection Overview

1. Control Connection RJ45
2. Paralleled BUS connection
3. LON Connection terminals A and B
4. 24VAC Power Connection

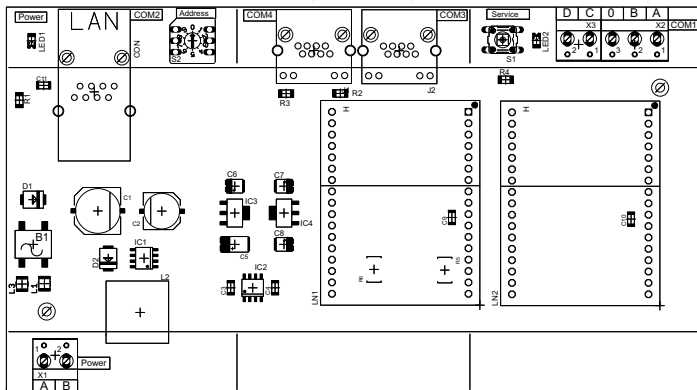

WARNING

When extending wire there is the possibility of exposure to electromagnetic interference. Avoid running wires beside or near high voltage 120/240 VAC conductors. If proximity to high voltage conductors cannot be avoided, use stranded, twisted pair of shield design wire. Ensure that only one end of the shielding is grounded.

Versatronik 501 Dial Setting Overview

Rotary Dial Setting

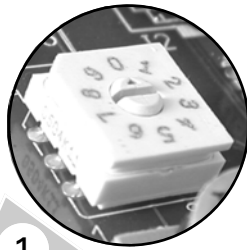

1

Setting Overview

1. The rotary dial setting on the Versatronik Gateways provides addressing information for systems that may utilize a number of Versatronik Gateways.

It is not required to make adjustments to the rotary dial setting. It should be left in the factory default position setting of 0.

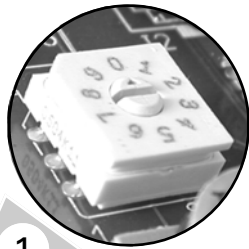
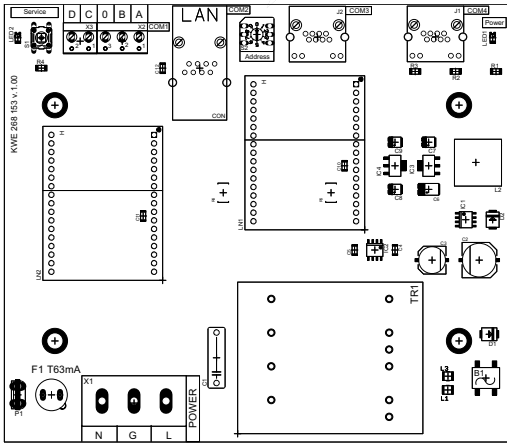

1

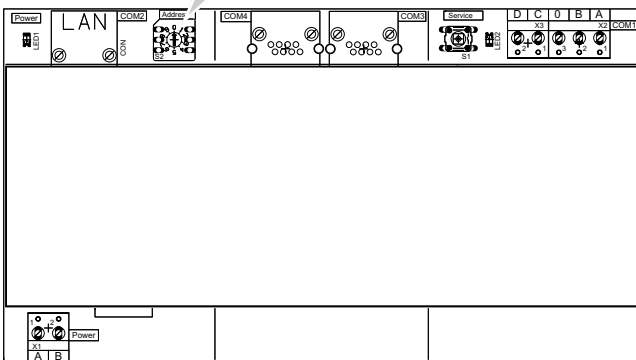

Connection Overview—120VAC

Communication connections—Vitotronic 100, GC1/GC1B, 300 GW2 or 300 GW5B
LON

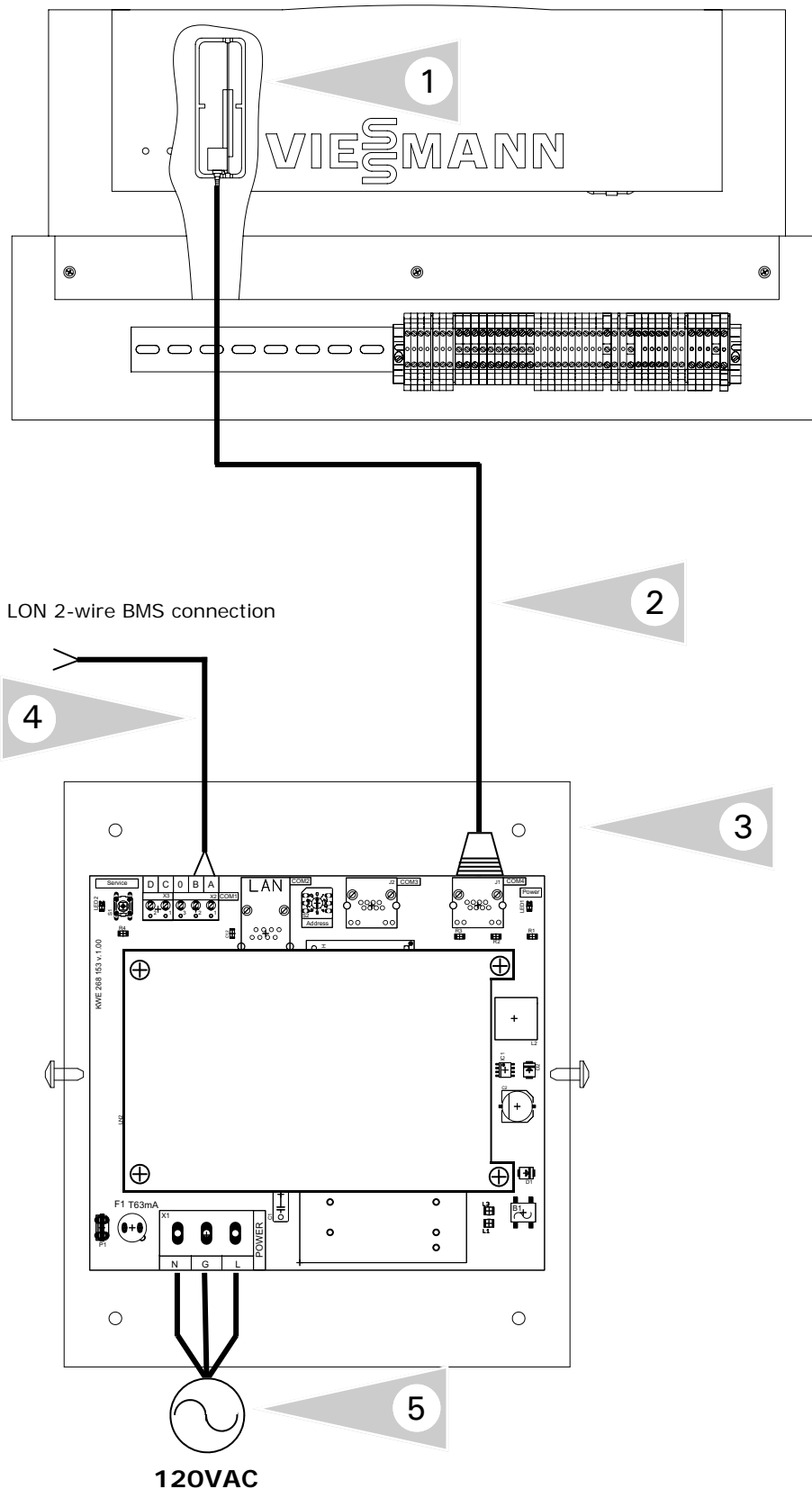

Connection Overview

Refer to manual specific to boiler control. Ensure necessary LON communication card installed.

- 1 Control showing location of LON card and its location within.
- 2 A 3'/91cm CAT-5 cable is supplied with the gateway. The RJ45 is plugged into the control and terminates into the RJ45 socket inside of the Versatronic 501 gateway.
- 3 Versatronic 501 gateway.
- 4 Field wiring for LON connection to terminals A and B.
- 5 Plug-in power cord for 120VAC Versatronic 501 gateways.

Connection Overview—24VAC

Communication connections—Vitotronic 100, GC1/GC1B, 300 GW2 or 300 GW5B
LON

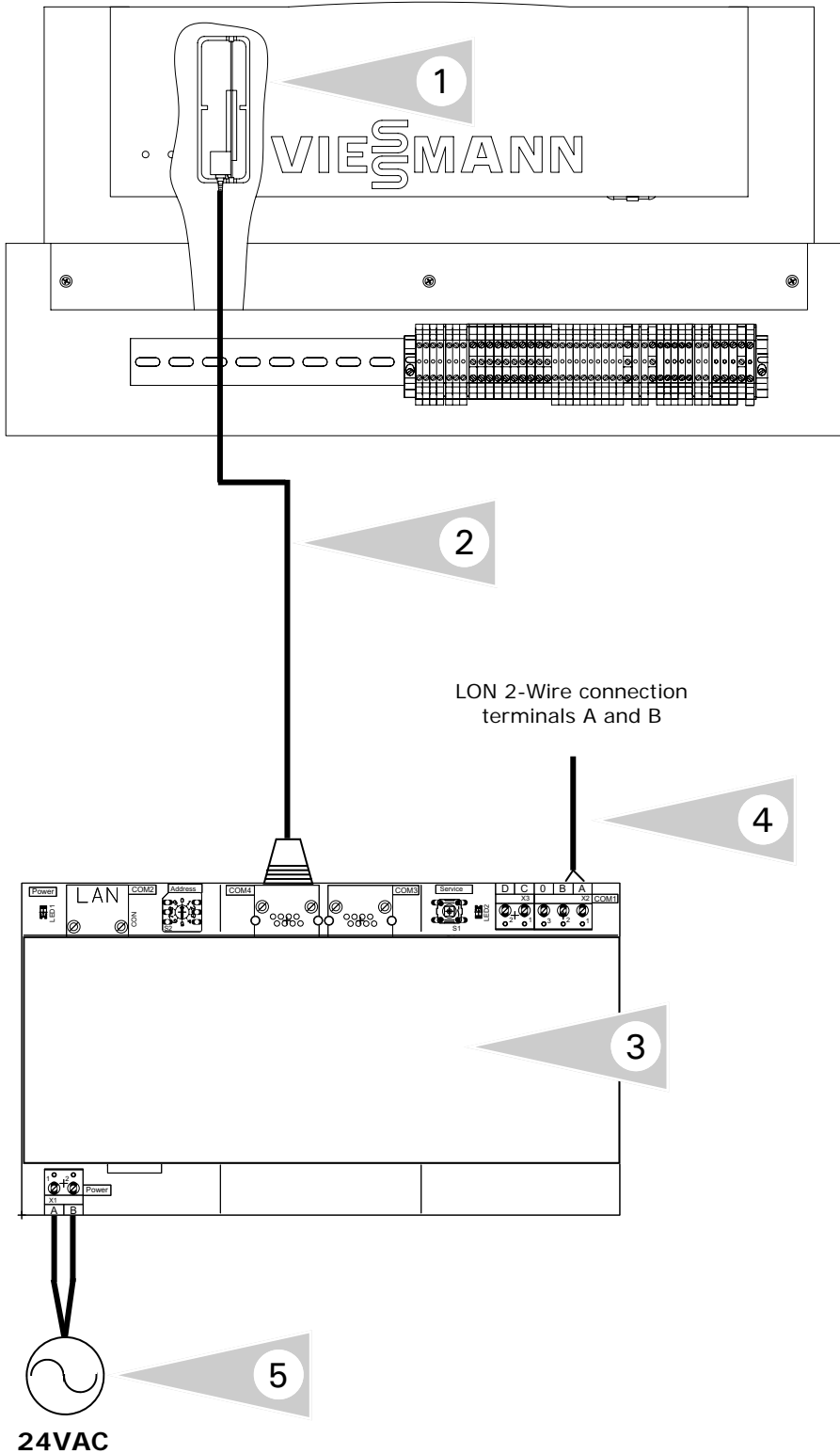

Connection Overview

Refer to manual specific to boiler/system control. Ensure necessary LON communication card installed.

- 1 Control showing location of LON card and its location within.
- 2 A 3'/91cm CAT-5 cable is supplied with the gateway. The RJ45 is plugged into the control and terminates into the RJ45 socket inside of the Versatronik 501 gateway.
- 3 Versatronik 501 gateway.
- 4 Field wiring for LON connection to terminals A and B.
- 5 Field-supplied 24VAC power supply for gateway.

Connection Overview—120VAC

Communication connections—Vitocontrol-S, CT3/VD2A or Vitotronic 300-K MW1B
LON

LON 2-wire BMS
Connection

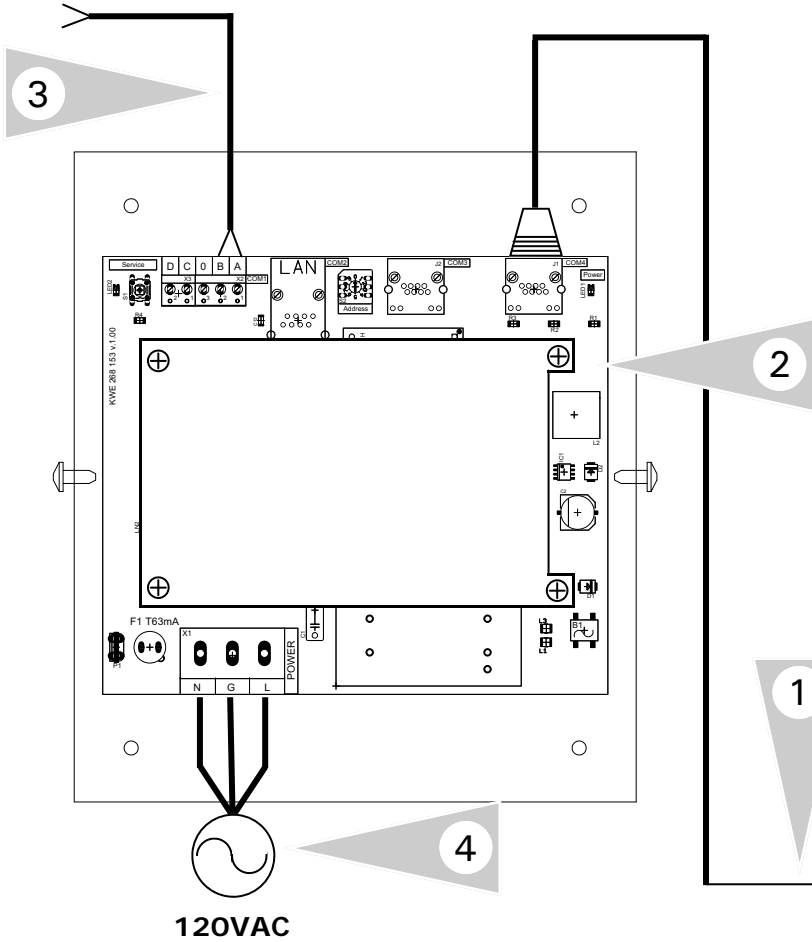

Connection Overview

Refer to manual specific to boiler/
system control. Ensure necessary LON
communication card installed.

- 1 A 3'/91cm CAT-5 cable is supplied with the gateway. The RJ45 is plugged into the control and terminates into the RJ45 socket inside of the Versatronic 501 gateway. Vitotronic 300K will need LON card installed.
- 2 Versatronic 501 gateway.
- 3 Field wiring for LON connection to terminals A and B.
- 4 Plug-in power cord for 120VAC Versatronic 501 gateways.

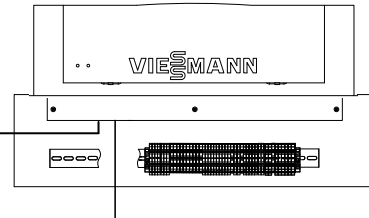

Connection Overview—24VAC

Communication connections—Vitocontrol-S, CT3/VD2A or Vitotronic 300-K MW1B
LON

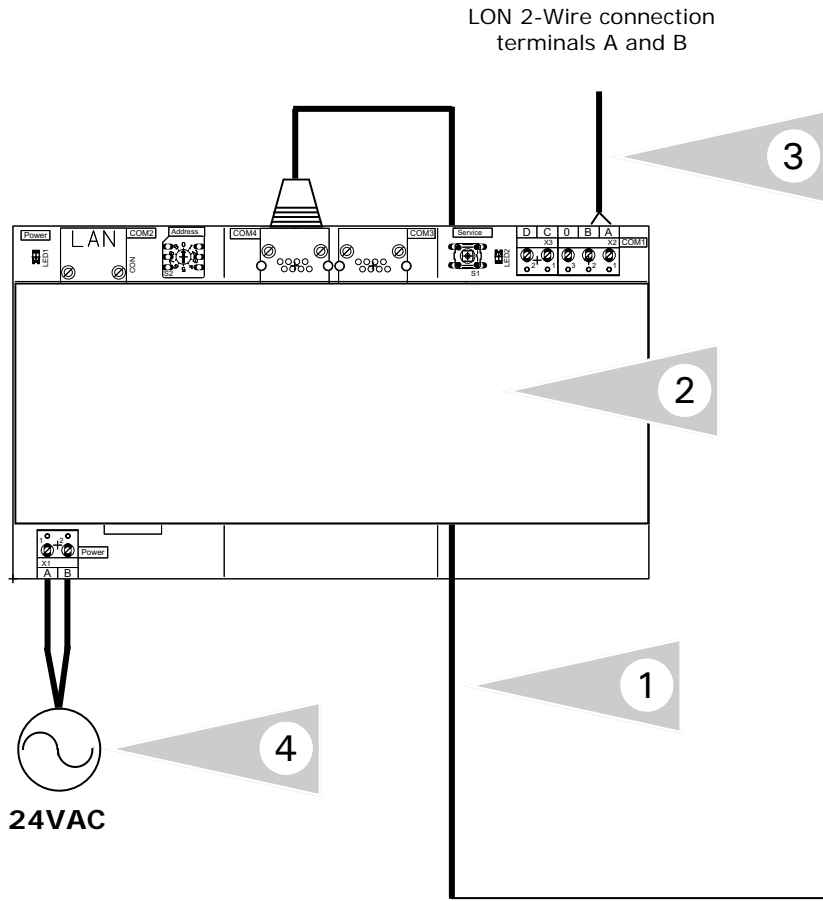

Connection Overview

Refer to manual specific to boiler control. Ensure necessary LON communication card installed.

- 1 A 3'/91cm CAT-5 cable is supplied with the gateway. The RJ45 is plugged into the control and terminates into the RJ45 socket inside of the Versatronik 501 gateway.
- 2 Versatronik 501 gateway.
- 3 Field wiring for LON connection to terminals A and B.
- 4 The RJ45 BACnetIP communication connection plugged into Versatronik 501 gateway.
- 5 Field-supplied 24VAC power supply for gateway.

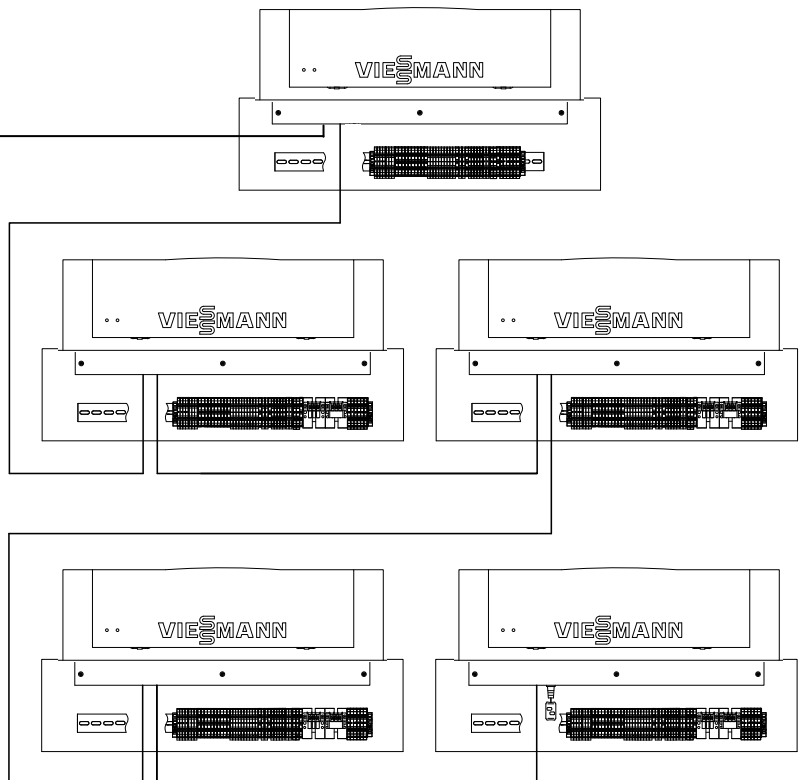

Connection Overview—120VAC

Communication connections—Vitocontrol-S, MW2 for Vitodens 200, WB2B or Vitotronic 300-K, MW2B LON

LON 2-wire BMS
Connection

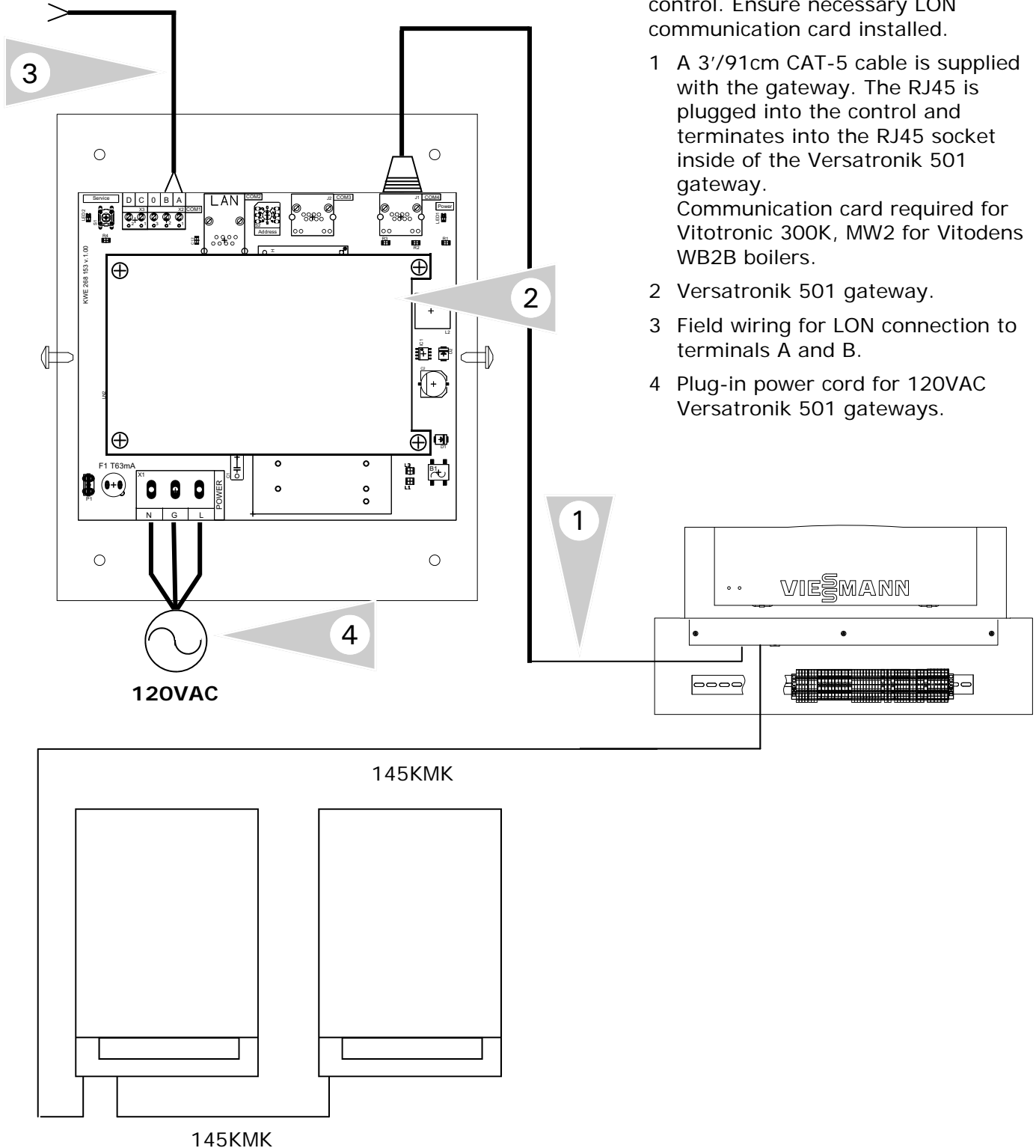

Connection Overview

Refer to manual specific to boiler control. Ensure necessary LON communication card installed.

- 1 A 3'/91cm CAT-5 cable is supplied with the gateway. The RJ45 is plugged into the control and terminates into the RJ45 socket inside of the Versatronic 501 gateway. Communication card required for Vitotronic 300K, MW2 for Vitodens WB2B boilers.
- 2 Versatronic 501 gateway.
- 3 Field wiring for LON connection to terminals A and B.
- 4 Plug-in power cord for 120VAC Versatronic 501 gateways.

Connection Overview—120VAC

Communication connections—Vitocontrol-S, MW2 for Vitodens 200, WB2B or Vitotronic 300-K, MW2B LON

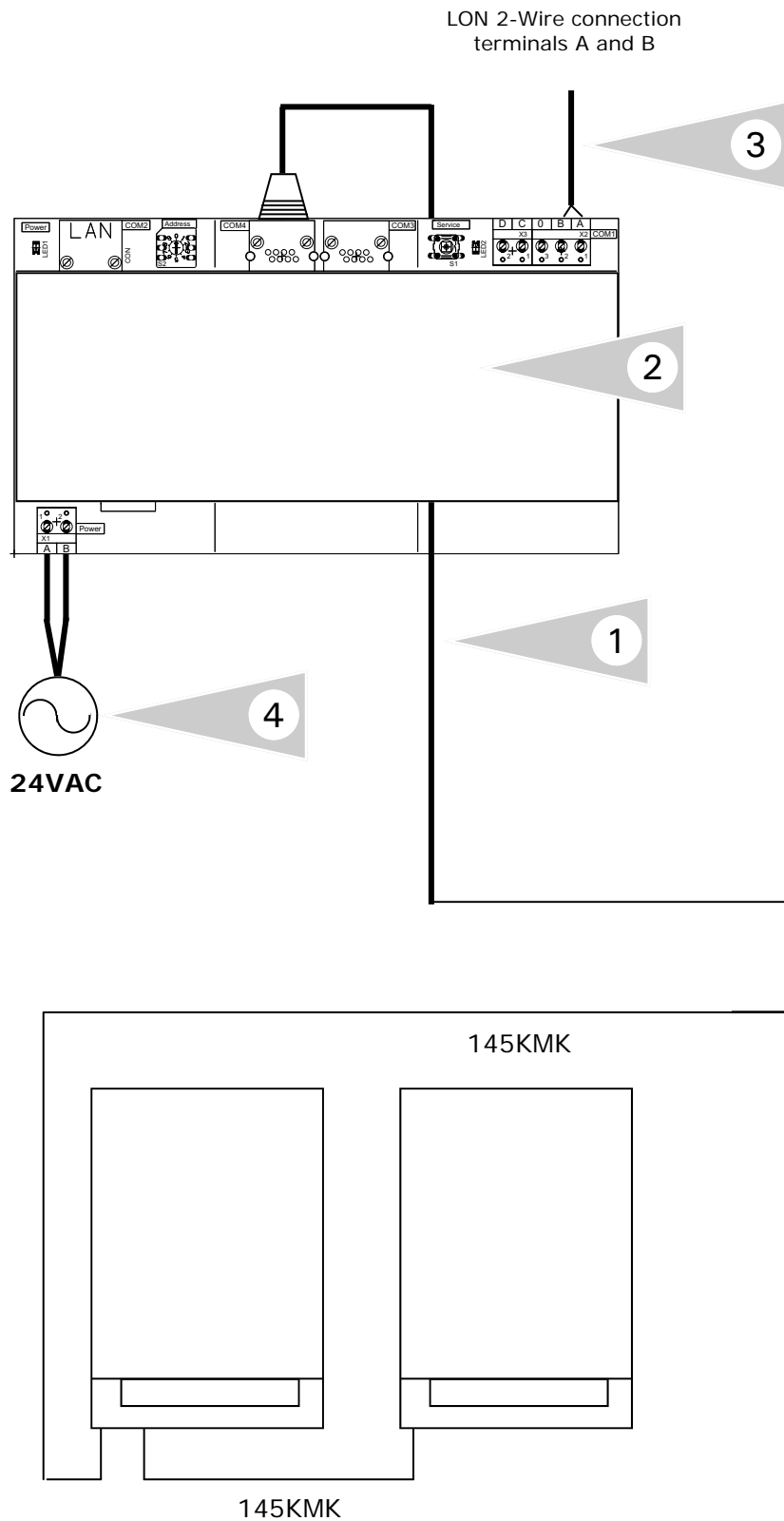

Connection Overview

Refer to manual specific to boiler control. Ensure necessary LON communication card installed.

- 1 A 3'/91cm CAT-5 cable is supplied with the gateway. The RJ45 is plugged into the control and terminates into the RJ45 socket inside of the Versatronik 501 gateway.
- 2 Versatronik 501 gateway.
- 3 Field wiring for LON connection to terminals A and B.
- 4 Field-supplied 24VAC power supply for gateway.

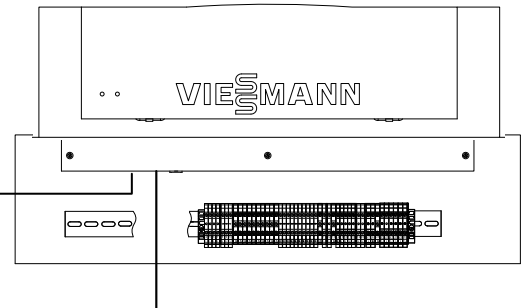

Connection Overview—120VAC

Communication connections—Vitodens 200, WB2B, HO1 and B2HA
LON

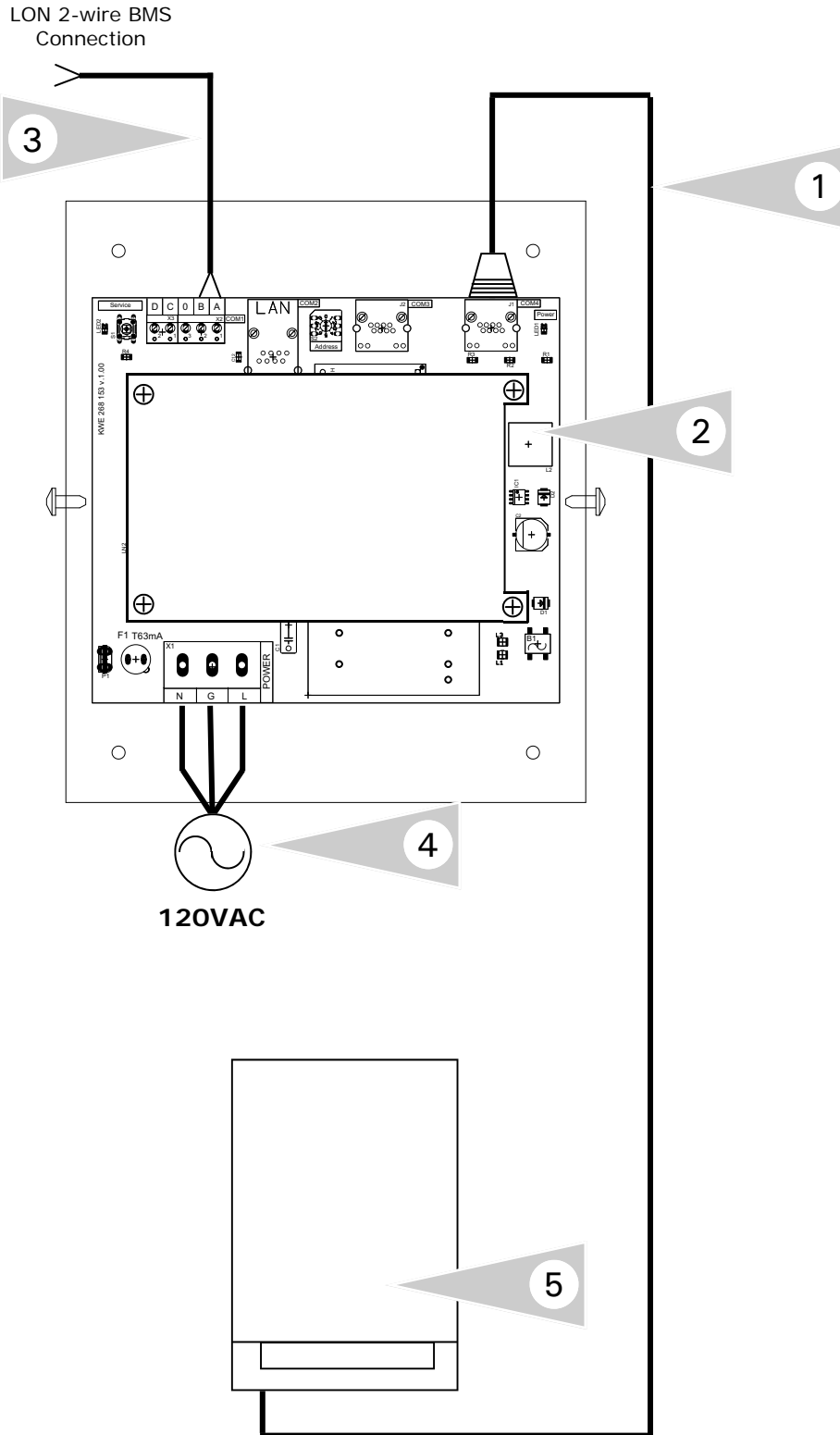

Connection Overview

Refer to manual specific to boiler control. Ensure necessary LON communication card installed.

- 1 A 3'/91cm CAT-5 cable is supplied with the gateway. The RJ45 is plugged into the control and terminates into the RJ45 socket inside of the Versatronik 501 gateway.
- 2 Versatronik 501 gateway.
- 3 Field wiring for LON connection to terminals A and B.
- 4 Plug-in power cord for 120VAC Versatronik 501 gateways.
- 5 Refer to boiler manual with respect to installing LON communications card inside of boiler control.

Connection Overview—24VAC

Communication connections—Vitodens 200, WB2B, HO1 and B2HA
LON

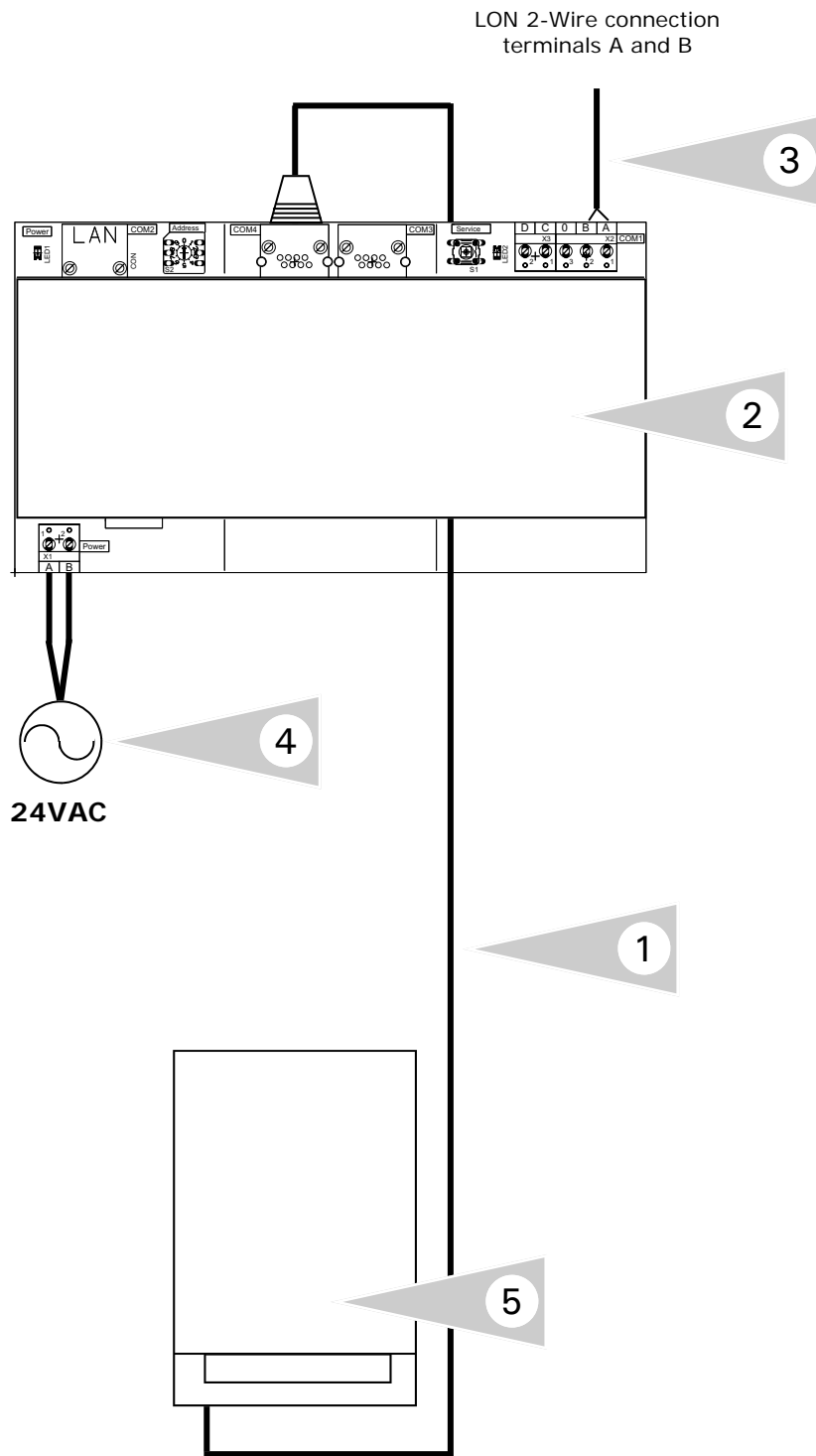

Connection Overview

Refer to manual specific to boiler control. Ensure necessary LON communication card installed.

- 1 A 3'/91cm CAT-5 cable is supplied with the gateway. The RJ45 is plugged into the control and terminates into the RJ45 socket inside of the Versatronik 501 gateway.
- 2 Versatronik 501 gateway.
- 3 Field wiring for LON connection to terminals A and B.
- 4 Field-supplied 24VAC power supply for Versatronik gateway.
- 5 Refer to boiler manual with respect to installing LON communications card inside of boiler control.

Update Participant List for Vitotronic 300K, Cascade Control

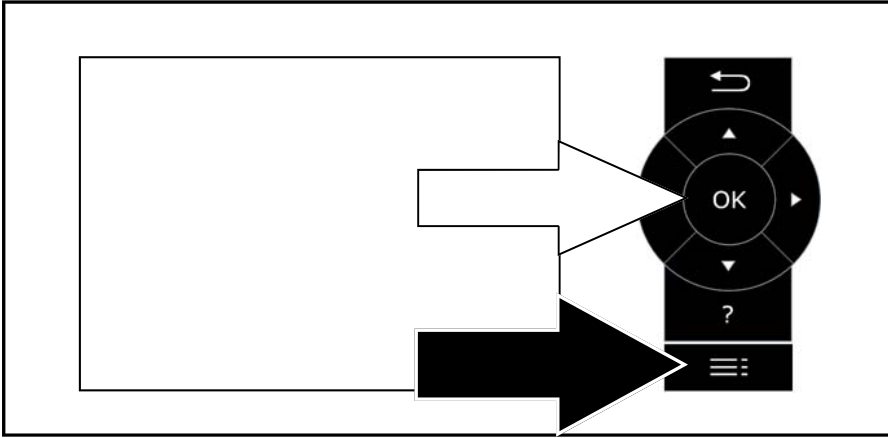

Participant Update

This is to be carried out after all the communication connections have been completed and the Vitotronic 300K, is coded as the error manager.

Requirements:
 Vitotronic 300K, must be coded as the error manager (default). Refer to the Vitotronic 300K manual address 79:01.

The LON participant number must be assigned in each of the Versatronic 501 gateway units. Refer to the rotary dial setting and ensure there are no duplicates.

Press the OK and lined Menu button simultaneously to bring up the **Service** menu option and press **OK**.

Arrow down to **Service Functions** and press **OK**.

When in the **Service Functions** screen, ensure **Participant Check** is highlighted. Arrow up or down to highlight if not and press **OK**.

Arrow down to **Delete List?** and press **OK**.

The LON Participant information will be updated as to the boiler controls and any other Versatronic LON devices.

Note:

Re-entering the Participant Check too early will result in the screen showing No Participant. Continue to wait for some time and then enter the Participant Check again. It may take time for all of the devices to report back.

Service
Diagnosis
Actuator
Coding Level 1
Fault History
Service Functions
Terminate Service?



Service Functions
Participant Check
Service PIN



Participant Check
Participant 1
Participant 2
Participant 3
Participant 4
Delete List?



KWE P/N 394037 Versatronic 501 and 501D LON Gateway V1.0 09/2013 Technical information subject to change without notice

Service
Diagnosis
Actuator
Coding Level 1
Fault History
Service Functions
Terminate Service?



Service Functions
Participant Check
Service PIN



Participant Check
Participant 1
Participant 2
Participant 3
Participant 4
Delete List?



Note:

Select **Delete List** if a participant number should not be part of the list or if the gateway addressing value has changed after the participant update/check. It will be removed and clear the communication fault that may be present.

Rotary Switch Position	Participant Value
0	55
1	56
2	57
3	58
4	59
5	60
6	61
7	62

Participant Check

The participant check is used to confirm communication between the boiler controls and the Vitotronic 300K, system control.

Requirements:

Vitotronic 300K, must be coded as the error manager (default). Refer to the Vitotronic 300K manual address 79:01. The LON participant number must be assigned in each of the Versatronic 501 gateway units. Refer to the rotary dial setting and ensure there are no duplicates.

1. Press the **OK** and **Menu** buttons simultaneously for approximately 2 seconds. This will allow the Service screen to appear.
2. With the arrow down button, select the **Service Functions** menu option.
3. Select **Participant Check** if not already highlighted and press **OK**.
4. With the arrow up or down buttons, select a Participant and press OK. The screen will show the check is active and will report back if it is okay or not.
5. If the check was successful, select a different user by using the arrow up or down buttons. Once selected press OK and repeat the same procedure as outlined in point 4.
6. To exit the Participant check, press the return button ↵.

Configuration of Gateway—LON

Configuration of *nciNR2Config*

Note: Status Light Operation

LED will flash once per second when **not** commissioned

LED will flash once every 5 seconds when commissioned and communicating with boiler plant.

nciNR2Config	NR2 Configuration Byte[0] - Boiler 1 LON Address Byte[1] - Boiler 2 LON Address Byte[2] - Boiler 3 LON Address Byte[3] - Boiler 4 LON Address Byte[4] - Zone/Cascade/Boiler LON Address Byte[5] - Number of Zones on the Zone/Cascade/Boiler	UNVT
--------------	--	------

The *nciNR2Config* settings are based on the programmed participant number at address 77 of the controls. Generally, the boiler controls are numbered 1 through 4. The Vitotronic 300K, Cascade Control is numbered 5.

Byte[5] is set 0 if no cascade or 1 through 3 for number of zones.

Any more controls other than the boiler controls and the Cascade controls, will require another a second or third gateway.

System Examples	<i>nciNR2Config</i> Configuration Settings					
	Byte [0]	Byte [1]	Byte [2]	Byte [3]	Byte [4]	Byte [5]
Single Vitotronic 100, GC1 Boiler Control	1	0	0	0	1	0
Vitotronic 200 HO1 (Vitodens 200, WB2B) w/MV	1	0	0	0	201	2
Vitodens 200 B2HA	1	0	0	0	201	1
Vitotronic 300, GW2 with 2 Mixing Valves	1	0	0	0	1	3
Vitotronic 300, GW5B with 2 Mixing Valves	1	0	0	0	1	3
Vitotronic 300-K, with 2 Vitotronic 100, GC1 (high temp & 1 MV)	1	2	0	0	5	2
Vitotronic 300-K, with 4 Vitotronic 100, GC1 (high temp & 2 MV)	1	2	3	4	5	3
Vitotronic 300-K (Vitodens 200, WB2B/B2HA) Boiler KMK Comm.	0	0	0	0	205	3
Vitotronic 050/200-H, HK1 Mixing Valve Control	0	0	0	0	10	1
Vitotronic 050/200-H, HK3 Mixing Valve Control	0	0	0	0	10	3

Note: Byte[5] is a function of Byte[4]. The Byte[5] setting determines the number of heating circuits of the Byte[4] control.

Byte[5] is set 0 if no cascade or 1 through 3 for number of zones.

Input Variable Overview

Input Variables

Values which can be written to the Versatronik 501 NR2/LON Gateway

Note:

Temperature values only possible with specific installed sensors based on particular installation

Vitotronic 100, GC1/GC1B	Vitodens 200 B2HA	Vitotronic 200, HO1	Vitotronic 300, GW2/GW5B	Vitotronic 333/300-K MW1	Vitotronic 300-K, MW2
--------------------------	-------------------	---------------------	--------------------------	--------------------------	-----------------------

Point	Point Description	SNVT Type	Points Available Y/N					
			Vitotronic 100, GC1/GC1B	Vitodens 200 B2HA	Vitotronic 200, HO1	Vitotronic 300, GW2/GW5B	Vitotronic 333/300-K MW1	Vitotronic 300-K, MW2
nciMaxSendtime	Max Sending Time – Heartbeat	107	Y	Y	Y	Y	Y	Y
nciNR2Config	NR2 Configuration Byte[0] - Boiler 1 LON Address Byte[1] - Boiler 2 LON Address Byte[2] - Boiler 3 LON Address Byte[3] - Boiler 4 LON Address Byte[4] - Zone/Cascade/Boiler LON Address Byte[5] - Number of Zones on the Zone/Cascade/Boiler	UNVT	Y	Y	Y	Y	Y	Y
nviCZDHWSet	Zone/Cascade/Boiler DHW Set-Point	105	Y	Y	Y	Y	Y	Y
nviCZ1Shift	Zone/Cascade/Boiler Zone A1 Curve Shift	105	N	Y	Y	Y	Y	Y
nviCZ1Slope	Zone/Cascade/Boiler Zone A1 Curve Slope	105	N	Y	Y	Y	Y	Y
nviCZ1RoomN	Zone/Cascade/Boiler Zone A1 Curve Room Temp. Normal	105	N	Y	Y	Y	Y	Y
nviCZ1RoomR	Zone/Cascade/Boiler Zone A1 Curve Room Temp. Reduce	105	N	Y	Y	Y	Y	Y
nviCZ1SupST	Zone/Cascade/Boiler Zone A1 Supply Set-Point	105	Y	Y	Y	Y	Y	Y
nviCZ2Shift	Zone/Cascade/Boiler Zone M2 Curve Shift	105	N	Y	Y	Y	Y	Y
nviCZ2Slope	Zone/Cascade/Boiler Zone M2 Curve Slope	105	N	Y	Y	Y	Y	Y
nviCZ2RoomN	Zone/Cascade/Boiler Zone M2 Curve Room Temp. Normal	105	N	Y	Y	Y	Y	Y
nviCZ2RoomR	Zone/Cascade/Boiler Zone M2 Curve Room Temp. Reduce	105	N	Y	Y	Y	Y	Y
nviCZ2SupST	Zone/Cascade/Boiler Zone M2 Supply Set-Point	105	N	Y	Y	Y	Y	Y
nviCZ3Shift	Zone/Cascade/Boiler Zone M3 Curve Shift	105	N	N	N	Y	Y	Y
nviCZ3Slope	Zone/Cascade/Boiler Zone M3 Curve Slope	105	N	N	N	Y	Y	Y
nviCZ3RoomN	Zone/Cascade/Boiler Zone M3 Curve Room Temp. Normal	105	N	N	N	Y	Y	Y
nviCZ3RoomR	Zone/Cascade/Boiler Zone M3 Curve Room Temp. Reduce	105	N	N	N	Y	Y	Y
nviCZ3SupST	Zone/Cascade/Boiler Zone M3 Supply Set-Point	105	N	N	N	Y	Y	Y

Output Variable Overview—LON

Output Variables

Values which can be read from the Versatronik 501 NR2/LON Gateway

Note:

Temperature values only possible with specific installed sensors based on particular installation

Vitotronic 100, GC1/GC1B	Vitodens 200, B2HA	Vitotronic 200, HO1	Vitotronic 300, GW2/GW5B	Vitotronic 333/300-K MW1	Vitotronic 300-K, MW2
--------------------------	--------------------	---------------------	--------------------------	--------------------------	-----------------------

Point	Point Description	SNVT Type	Points Available Y/N					
			Vitotronic 100, GC1/GC1B	Vitodens 200, B2HA	Vitotronic 200, HO1	Vitotronic 300, GW2/GW5B	Vitotronic 333/300-K MW1	Vitotronic 300-K, MW2
nvoB1Temp	Boiler 1 actual temperature	105	Y	Y	Y	Y	Y	Y
nvoB1RetT1	Boiler 1 actual return temperature sensor 1 (17A for GC1/GC1B)	105	Y	N	N	Y	Y	N
nvoB1FlueGT	Boiler 1 flue gas actual temperature	105	Y	Y	Y	Y	Y	N
nvoB1FaultCode	Boiler 1 fault code (Appendix A)	8	Y	Y	Y	Y	Y	N
nvoB1RelayState	Boiler 1 relay state (Appendix B)	83	Y	Y	Y	Y	Y	Y
nvoB2Temp	Boiler 2 actual temperature	105	N	N	N	N	Y	Y
nvoB2RetT1	Boiler 2 actual return temperature sensor 1 (17A for GC1/GC1B)	105	N	N	N	N	Y	N
nvoB2FlueGT	Boiler 2 flue gas actual temperature	105	N	N	N	N	Y	N
nvoB2FaultCode	Boiler 2 fault code (Appendix A)	8	N	N	N	N	Y	N
nvoB2RelayState	Boiler 2 relay state (Appendix B)	83	N	N	N	N	Y	Y
nvoB3Temp	Boiler 3 actual temperature	105	N	N	N	N	Y	Y
nvoB3RetT1	Boiler 3 actual return temperature sensor 1 (17A for GC1/GC1B)	105	N	N	N	N	Y	N
nvoB3FlueGT	Boiler 3 flue gas actual temperature	105	N	N	N	N	Y	N
nvoB3FaultCode	Boiler 3 fault code (Appendix A)	8	N	N	N	N	Y	N
nvoB3RelayState	Boiler 3 relay state (Appendix B)	83	N	N	N	N	Y	Y
nvoB4Temp	Boiler 4 actual temperature	105	N	N	N	N	Y	Y
nvoB4RetT1	Boiler 4 actual return temperature sensor 1 (17A for GC1/GC1B)	105	N	N	N	N	Y	N
nvoB4FlueGT	Boiler 4 flue gas actual temperature	105	N	N	N	N	Y	N
nvoB4FaultCode	Boiler 4 fault code (Appendix A)	8	N	N	N	N	Y	N
nvoB4RelayState	Boiler 4 relay state (Appendix B)	83	N	N	N	N	Y	Y
nvoBStatus	Modulation Status in % Byte [0] Boiler 1 Byte [1] Boiler 2 Byte [2] Boiler 3 Byte [3] Boiler 4 Note: The burner percentage is a only a control approximation and does not reflect the actual burner position. To obtain actual burner position, refer to the manufacturer of the burner or the supplied documentation for the burner.	UNVT	Y	Y	Y	Y	Y	Y

Output Variable Overview Continued

Output Variables

Values which can be read from the Versatronik 501 NR2/LON Gateway

Note:

Temperature values only possible with specific installed sensors based on particular installation

Vitotronic 100, GC1/GC1B	Vitodens 200, B2HA	Vitotronic 200, HO1	Vitotronic 300, GW2/GW5B	Vitotronic 333/300-K MW1	Vitotronic 300-K, MW2
--------------------------	--------------------	---------------------	--------------------------	--------------------------	-----------------------

Point	Point Description	SNVT Type	Points Available Y/N					
			Vitotronic 100, GC1/GC1B	Vitodens 200, B2HA	Vitotronic 200, HO1	Vitotronic 300, GW2/GW5B	Vitotronic 333/300-K MW1	Vitotronic 300-K, MW2
nvoCZOutD	Zone/Cascade/Boiler Outdoor temperature	105	N	Y	Y	Y	Y	Y
nvoCZRelayState	Zone/Cascade/Boiler Relay State (Appendix B)	83	N	Y	Y	Y	Y	Y
nvoCZFaultCode	Zone/Cascade/Boiler Fault Code (Appendix A)	8	N	Y	Y	Y	Y	Y
nvoCZDHWSet	Zone/Cascade/Boiler DHW Set-Point	105	Y	Y	Y	Y	Y	Y
nvoCZDHWAct	Zone/Cascade/Boiler DHW Actual Temperature	105	Y	Y	Y	Y	Y	Y
nvoCZ1SupST	Zone/Cascade/Boiler Zone A1 Supply Set-Point	105	N	Y	Y	Y	Y	Y
nvoCZ1SupAT	Zone/Cascade/Boiler Zone A1 Supply Actual Temperature	105	N	Y	Y	Y	Y	Y
nvoCZ1RetT	Zone/Cascade/Boiler Zone A1 Actual Return Temperature	105	N	Y	Y	Y	Y	Y
nvoCZ1Shift	Zone/Cascade/Boiler Zone A1 Curve Shift	105	N	Y	Y	Y	Y	Y
nvoCZ1Slope	Zone/Cascade/Boiler Zone A1 Curve Slope	105	N	Y	Y	Y	Y	Y
nvoCZ1RoomN	Zone/Cascade/Boiler Zone A1 Curve Room Temp. Normal	105	N	Y	Y	Y	Y	Y
nvoCZ1RoomR	Zone/Cascade/Boiler Zone A1 Curve Room Temp. Reduce	105	N	Y	Y	Y	Y	Y
nvoCZ2SupST	Zone/Cascade/Boiler Zone M2 Supply Set-Point	105	N	Y	Y	Y	Y	Y
nvoCZ2SupAT	Zone/Cascade/Boiler Zone M2 Supply Actual Temperature	105	N	Y	Y	Y	Y	Y
nvoCZ2Shift	Zone/Cascade/Boiler Zone M2 Curve Shift	105	N	Y	Y	Y	Y	Y
nvoCZ2Slope	Zone/Cascade/Boiler Zone M2 Curve Slope	105	N	Y	Y	Y	Y	Y
nvoCZ2RoomN	Zone/Cascade/Boiler Zone M2 Curve Room Temp. Normal	105	N	Y	Y	Y	Y	Y
nvoCZ2RoomR	Zone/Cascade/Boiler Zone M2 Curve Room Temp. Reduce	105	N	Y	Y	Y	Y	Y
nvoCZ3SupST	Zone/Cascade/Boiler Zone M3 Supply Set-Point	105	N	N	N	Y	Y	Y
nvoCZ3SupAT	Zone/Cascade/Boiler Zone M3 Supply Actual Temperature	105	N	N	N	Y	Y	Y
nvoCZ3Shift	Zone/Cascade/Boiler Zone M3 Curve Shift	105	N	N	N	Y	Y	Y
nvoCZ3Slope	Zone/Cascade/Boiler Zone M3 Curve Slope	105	N	N	N	Y	Y	Y
nvoCZ3RoomN	Zone/Cascade/Boiler Zone M3 Curve Room Temp. Normal	105	N	N	N	Y	Y	Y
nvoCZ3RoomR	Zone/Cascade/Boiler Zone M3 Curve Room Temp. Reduce	105	N	N	N	Y	Y	Y

Fault Codes

Appendix A—Fault Codes

Error codes for Viessmann control units based on controls/equipment installed

Fault Code (hex)	Fault Code (Dec)	Description
00	00	System without fault
0F	15	Perform maintenance check-up
10	16	Short circuit, outdoor temperature sensor
18	24	Interruption, outdoor temperature sensor
20	32	Short circuit, supply temperature sensor HC1/system
28	40	Interruption, supply temperature sensor HC1/system
30	48	Short circuit, boiler water temperature sensor
38	56	Interruption, boiler water temperature sensor
40	64	Short circuit, supply temperature sensor heating circuit 2
41	65	Short circuit, return temperature sensor heating circuit 2
44	68	Short circuit, supply temperature sensor heating circuit 3
45	69	Short circuit, return temperature sensor heating circuit 3
48	72	Interruption, supply temperature sensor heating circuit 2
49	73	Interruption, return temperature sensor heating circuit 2
4C	76	Interruption, supply temperature sensor heating circuit 3
4d	77	Interruption, return temperature sensor heating circuit 3
50	80	Short circuit, DHW tank temperature sensor
51	81	Short circuit, DHW tank temperature sensor 2
58	88	Interruption, DHW tank temperature sensor
59	89	Interruption, DHW tank temperature sensor 2
60	96	Short circuit, return temperature sensor 17
68	104	Interruption, return temperature sensor 17
70	112	Short circuit, supply/return temperature sensor 17B
78	120	Interruption, supply/return temperature sensor 17B
92	146	Solar: collector temperature short circuit
93	147	Solar: collector return temperature short circuit
94	148	Solar: collector DHW tank temperature sensor short circuit
9A	154	Solar: collector temperature sensor open circuit
9B	155	Solar collector return temperature sensor open circuit
9C	156	Solar: DHW tank temperature sensor open circuit
9F	159	Solar: general fault message
A7	167	Fault control unit wireless clock module
AE	174	Internal fault mixing valve
AF	175	Internal fault mixing valve
b0	176	Short circuit, flue gas temperature sensor
b1	177	Communication fault, programming unit (internal)
b4	180	Internal fault
b5	181	Internal fault
b6	182	Internal fault, invalid hardware recognition
b7	183	Internal fault, boiler protection coding card
b8	184	Interruption, flue gas temperature sensor
bA	186	Fault, mixing valve module (KM-BUS)
bC	188	Fault, Vitotrol heating circuit 1 (KM-BUS)
bd	186	Fault, Vitotrol heating circuit 2 (KM-BUS)
bE	190	Fault, Vitotrol heating circuit 3 (KM-BUS)
C1	193	External fault indication, boiler
C2	194	Communication fault solar control unit (KM-BUS)

Fault Codes Continued

Appendix A—Fault Codes Continued

Error codes for Viessmann control units based on controls/equipment installed

Fault Code (hex)	Fault Code (Dec)	Description
C5	197	Fault, speed controlled pump heating circuit 1 (KM-BUS)
C6	198	Fault, speed controlled pump heating circuit 2 (KM-BUS)
C7	199	Fault, speed controlled pump heating circuit 3 (KM-BUS)
C8	200	Fault, water level control
C9	201	Fault, maximum pressure
CA	202	Fault, minimum pressure/maximum pressure 2
Cb	203	Fault, maximum pressure 2
CC	204	Reserved, external periphery
Cd	205	Communication fault, Vitocom 300 (KM-BUS)
CE	206	Communication fault, fault indicator module (KM-BUS)
CF	207	Communication fault: wrong LON module
d1	209	Burner fault, boiler
d4	212	Fixed high limit fault, boiler
d5	213	Cascade: boiler is not responding
d6	214	External fault 1, plug-in adaptor
d7	215	External fault 2, plug-in adaptor
d8	216	External fault 3, plug-in adaptor
dA	218	Short circuit, room temperature sensor heating circuit 1
db	219	Short circuit, room temperature sensor heating circuit 2
dC	220	Short circuit, room temperature sensor heating circuit 3
dd	221	Interruption, room temperature sensor heating circuit 1
dE	222	Interruption, room temperature sensor heating circuit 2
dF	223	Interruption, room temperature sensor heating circuit 3
E0	224	Fault, external participant/device connected to LON
E4	228	Fault power supply voltage
E5	229	Internal fault combustion control unit
E6	230	Flue gas/air supply system blocked
F0	240	Communication fault combustion control unit
F1	241	Flue gas temperature limit has tripped
F2	242	Temperature limit has tripped
F3	243	Flame signal is present at burner start
F4	244	Flame signal is not present
F5	245	Air pressure switch not open for burner start
F6	246	Gas pressure switch not open for burner start
F7	247	Air pressure sensor short circuit or offset value outside of tolerances
F8	248	Fuel valve closure delayed
F9	249	Blower speed too low at burner start
FA	250	Blower speed too high at burner start
FC	252	Control of modulation valve defective
FD	253	Fault combustion control unit
FE	254	Coding plug defective or wrong EMV error
FF	255	Internal fault

Additional Alarm/Fault Information

Viessmann controls show fault codes in hexadecimal format to conserve screen space on the user interface of the boiler and system controls. The Versatronik 501 gateway uses a SNVT_count variable which is usually displayed in decimal format.

The base-format in which this fault can be displayed depends on your BMS software. This example shows how to display this fault code in hexadecimal, and Text format in Niagara AX.

To display in hex, you can use the KitControl -> Util "Numeric Bit And" object's mask input.

To display the equivalent fault text value, you can use the KitControl -> Conversion "Numeric To Enum" object and type out the enum range for all Viessmann error codes.

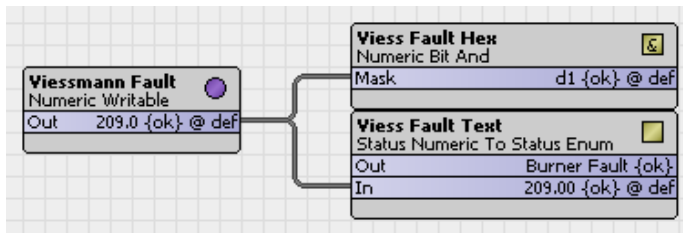

These values can now be displayed on a px webpage by pointing a Bound Label to the appropriate slot values.

Fault Code: d1 (Burner Fault)

Status Information

Appendix B—Status Information

x = always available for this device

k = dependent on configuration of device

n = not available for this device

Bit	Relay State								
		Vitotronic 100, GC1/GC1B	Vitotronic 300, GW2/GW5B	Vitotronic 333/300-K MW1	Vitotronic 050/200H HK1M	Vitotronic 050 HK1 Panel	Vitotronic 050 HK3 Panel	Vitotronic 300-K, MW1B, MW2B	Vitodens 200, HO1/Vitodens 200 B2HA
0	bit 2 ⁰ : DHW tank loading pump	k	k	k	n	k	k	k	k
1	bit 2 ¹ : Re-circulation pump	n	k	k	n	k	k	k	k
2	bit 2 ² : Heating circuit pump 1	n	k	k	x	x	k	k	x
3	bit 2 ³ : Heating circuit pump 2	n	k	k	n	n	k	k	k
4	bit 2 ⁴ : Heating circuit pump 3	n	k	k	n	n	k	k	n
5	bit 2 ⁵ : Night-time contact HKP 1	n	k	k	x	x	k	k	x
6	bit 2 ⁶ : Night-time contact HKP 2	n	k	k	n	n	k	k	k
7	bit 2 ⁷ : Night-time contact HKP 3	n	k	k	n	n	k	k	n
8	bit 2 ⁸ : Supply pump	n	n	n	k	k	k	n	n
9	bit 2 ⁹ : Primary pump heat exchanger set for DHW tank loading	k	k	k	n	k	k	k	n
	bit 2 ⁹ : DHW tank pump	n	n	n	n	n	n	n	k
10	bit 2 ¹⁰ : Boiler circuit and distribution (common supply) pump	k	k	k	n	n	n	n	k
	bit 2 ¹⁰ : Internal Pump	n	n	n	n	n	n	k	x
11	bit 2 ¹¹ : Shunt pump	k	k	k	n	n	n	n	n
	bit 2 ¹¹ : Diverting valve in space heating position	n	n	n	n	n	n	n	k
12	bit 2 ¹² : Flue gas heat exchanger pump	x	n	n	n	n	n	n	n
13	bit 2 ¹³ : ThermControl switching contact	k	n	n	n	n	n	n	n
	bit 2 ¹³ : Diverting valve in DHW position	n	n	n	n	n	n	n	k
14	bit 2 ¹⁴ : Burner 1 st stage	x	x	n	n	n	n	n	n
15	bit 2 ¹⁵ : Burner fault	x	x	n	n	n	n	n	n
	bit 2 ¹⁵ : Compiled fault	n	n	n	n	n	n	n	x

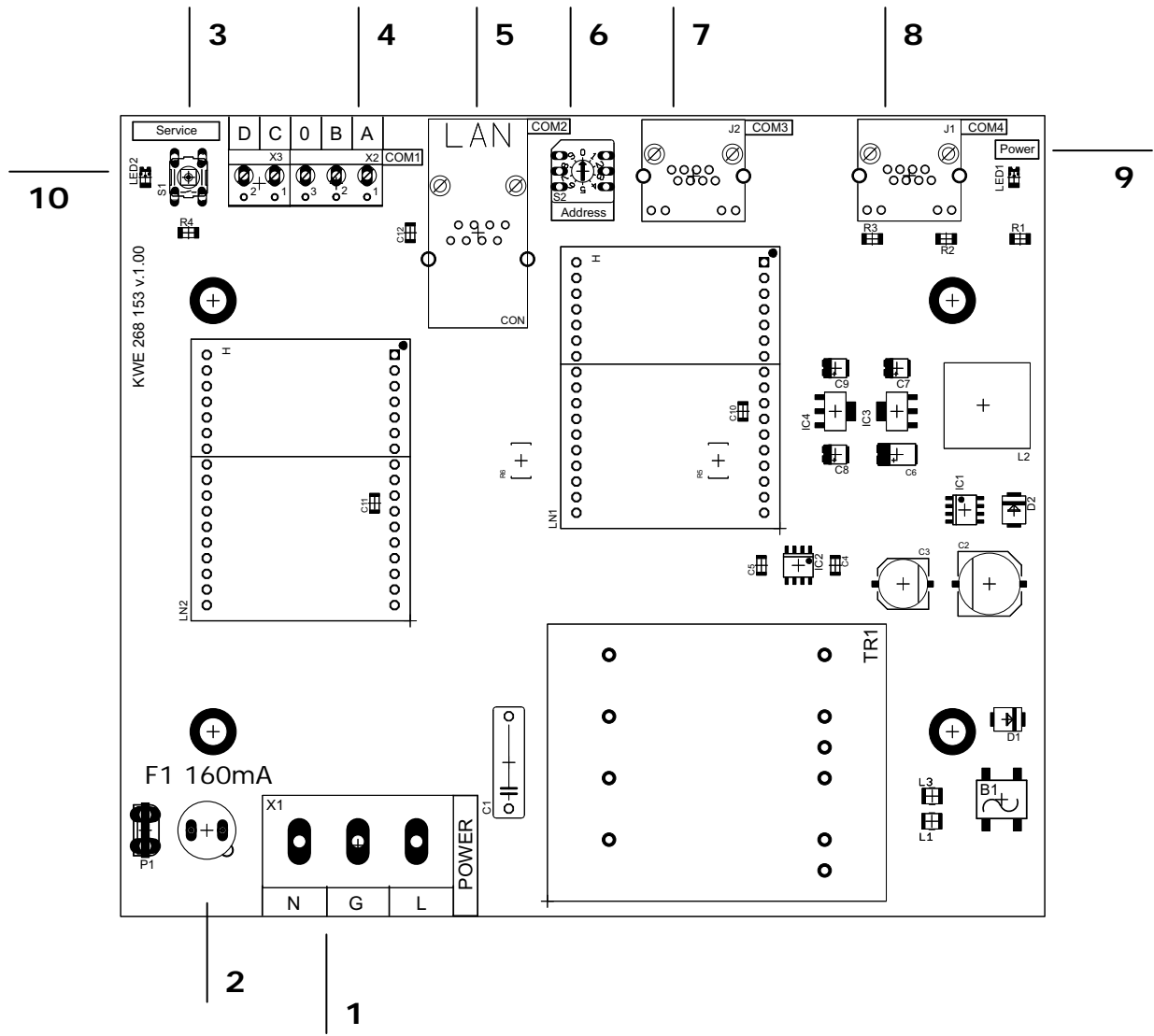

PCB Identifiers

1	120VAC Power Supply Connections
2	Fuse
3	Service Button
4	LON Connections to BMS
5	RJ45 Connection to BMS BACnet
6	Addressing selector for multiple modules
7	COM3 for multiple BUS connections
8	COM4 RJ45 Connection to control
9	Power LED indicator
10	Service LED

Specifications

Voltage Requirements	120VAC
Fuse Rating	160mA Time Delay
Power	4VA
Communication Connections	Supplied cable between devices

CAUTION

Static sensitive components may be damaged by improper handling or work within the control. Ensure all possible measures are taken to eliminate build-up of static electricity.

KWE P/N 394037 Versatronik 501 and 501D LON Gateway V1.0 09/2013 Technical information subject to change without notice

Technical Information

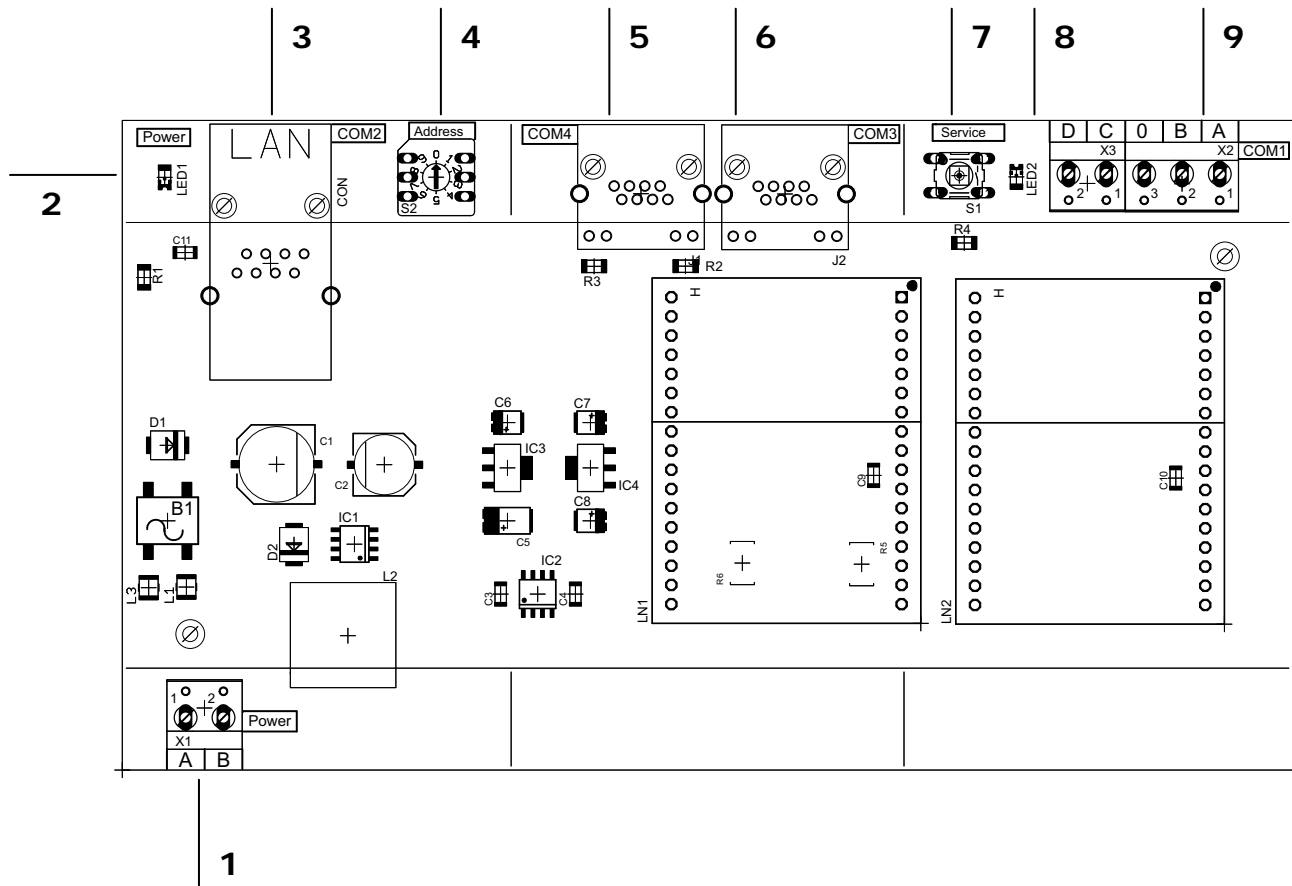

PCB Identifiers

1	24VAC Power Supply Connections
2	Power LED indicator
3	BACnet RJ45 BMS Connection
4	Addressing dial for multiple units
5	COM4 RJ45 Connection to control
6	COM3 for multiple BUS connections
7	Service button
8	Service LED
9	LON Connections to BMS

Specifications

Voltage Requirements	24VAC
Fuse Rating	N/A
Power	4VA
Communication Connections	Supplied cable between devices



CAUTION
 Static sensitive components may be damaged by improper handling or work within the control. Ensure all possible measures are taken to eliminate build-up of static electricity.

KWE Technologies Group
750 McMurray Road
Waterloo, Ontario, Canada
N2V 2G5
Tel: (519) 747-5042
Fax: (519) 747-4448
www.kwe-tech.com
info@kwe-tech.com

