

Versatronik® 515 & 515D

Communication Gateway
BACnet IP (Type B)



Document Applicable to:

Wall Mount 120VAC
Versatronik 515 NR2/BACIP (704079)
DIN Rail Mount 24VAC
Versatronik 515D NR2/BACIP (704080)

Applicable Controls

Vitotronic 100, GC1/GC1B
Vitotronic 300, GW2
Vitotronic 300, GW5B
Vitotronic 200, HO1
Vitodens 200 B2HA

Technical, Installation and Configuration Information

Cautionary Statement

The information presented in this document is only to be used by those familiar with its application and use.



C US LR 102874

IMPORTANT

Read and save these instructions for future reference

About these instructions



Take note of all symbols and notations intended to draw attention to potential hazards or important product information. These include "WARNING", "CAUTION" and "IMPORTANT". See below.

	WARNING
Indicates an imminently hazardous situation which, if not avoided, could result in death, serious injury or substantial product/property damage.	

→ Warnings draw your attention to the presence of potential hazards or important product information.

	CAUTION
Indicates an imminently hazardous situation which, if not avoided, may result in minor injury or product/property damage.	

→ Cautions draw your attention to the presence of potential hazards or important product information

	CAUTION
Static sensitive components may be damaged by improper handling or work within the control. Ensure all possible measures are taken to eliminate build-up of static electricity.	

IMPORTANT

→ Helpful hints for installation, operation or maintenance which pertains to the product.

Trademark Information

Viessmann® and Vitotronic® are trademarks of Viessmann Werke GmbH & Co KG registered in the United States and other countries.

Please visit:
www.viessmann.ca
www.viessmann.us

Echelon®, LON®, LONWORKS®, i.LON®, LNS®, LONMARK®, Neuron®, and the LonUsers logo are trademarks of Echelon Corporation registered in the United States and other countries.

Please visit:
www.echelon.com



BACnet® is a registered trademark of the American Society of Heating, Refrigerating and Air-Conditioning Engineers, Inc., 1791 Tullie Circle NE, Atlanta, GA 30329.

For more information please visit:
www.bacnet.org
www.ashrea.org

Important Regulatory and Installation Requirements

Codes

The installation of this unit must be in accordance with local codes.

→ Please carefully read this manual prior to attempting installation. Any warranty is null and void if these instructions are not followed.

All electrical wiring is to be done in accordance with the latest edition of CSA C22,1 Part 1 and/or local codes. In the U.S. use the National Electrical Code ANSI/NFPA 70.

→ The completeness and functionality of field supplied electrical controls and components must be verified by those installing the device

The installing contractor must comply with the Standard of Controls and Safety Devices for Automatically fired Boilers, ANSI/ASME CSD-1 where required by the authority having jurisdiction.

Working on the equipment

The installation, adjustment, service and maintenance of this unit must be done by a licensed professional heating contractor or persons who are qualified and experienced in the installation, service, and maintenance of similar products. There are no user serviceable parts on this control.

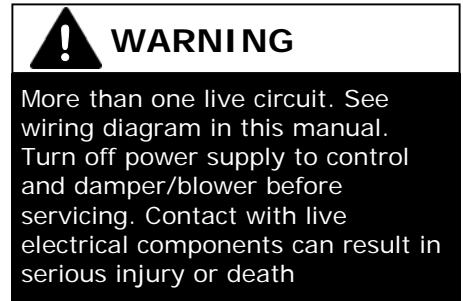

Power supply

Install power supply in accordance with the regulation of the authorities having jurisdiction or in absence of such requirements, in accordance with National Codes.

Purpose of Device and Operation

The Versatronik 515 gateway provides a communication translation between applicable controls and DDC systems which are capable of BACnet IP communications.

The Versatronik gateway may be either part of a control panel or stand-alone control device.

The type B gateway is used on multi-LON enabled Viessmann boiler controls which do not communicate with a Vitocontrol Cascade control. It is designed to allow BMS integration with high number of boilers independent of the Viessmann Cascade control.

This page is intentionally left blank

KWE P/N 394045 Versatronik 515 and 515D BACIP Type B Gateway V1.1 Feb 2014 Technical information subject to change without notice

Installation

Mounting Versatronik Gateway—120VAC Unit

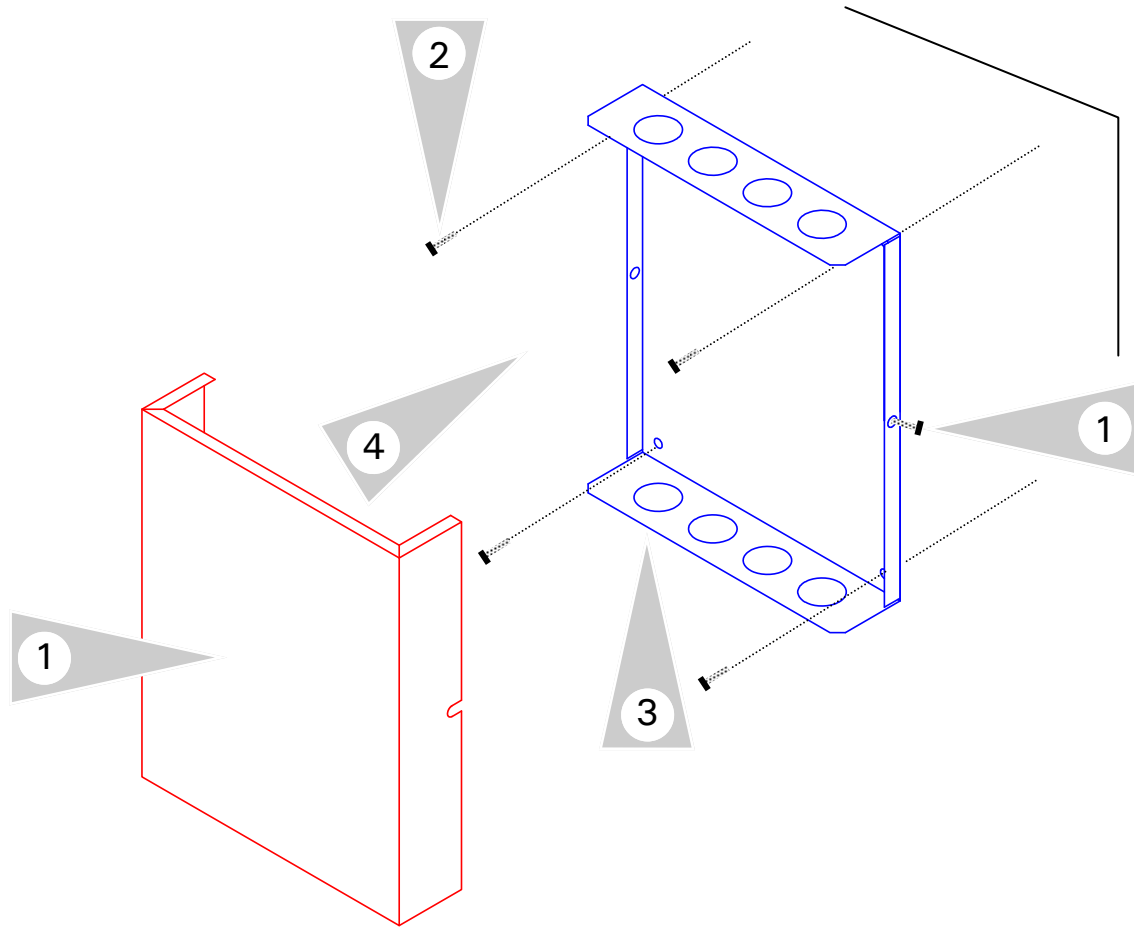

Mounting Steps

1. Mount Versatronik 515 Gateway in a convenient location near the connected boiler controls control. Remove cover by loosening the two screws on either side of base to release the cover.
2. Fasten base to wall using field-supplied screws/fasteners.
3. Remove knockout and installed wire strain relief or box connector. Removal of remaining knockouts is required to make further connections.
4. Once all of the 120VAC and low voltage connections are complete and verified, reinstall the cover from Step 1.



WARNING

When extending wire there is the possibility of exposure to electromagnetic interference. Avoid running wires beside or near high voltage 120/240 VAC conductors. If proximity to high voltage conductors cannot be avoided, use stranded, twisted pair of shield design wire. Ensure that only one end of the shielding is grounded.

Installation

Mounting Versatronik Gateway—24VAC DIN Rail Unit

Mounting Steps

1. Mount Versatronik 515D Gateway onto DIN rail within an enclosure in a convenient location near the boiler controls.
2. Make all the necessary connections including the field supplied 24VAC power connection.

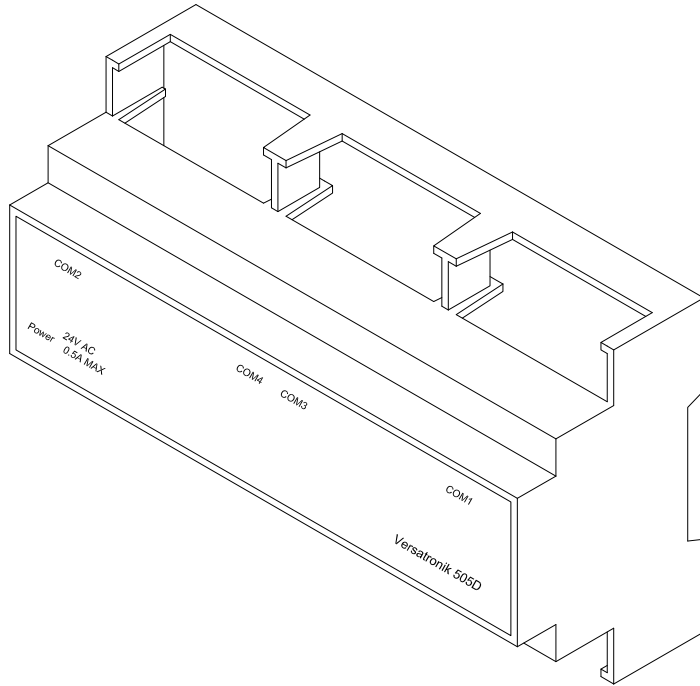

Connection Overview

1. BACnet IP RJ45 connection.
2. Control Connection RJ45
3. Paralleled BUS connection
4. 24VAC Power Connection

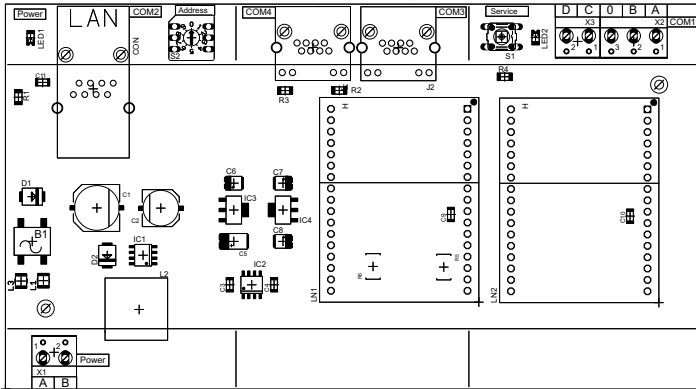

WARNING

When extending wire there is the possibility of exposure to electromagnetic interference. Avoid running wires beside or near high voltage 120/240 VAC conductors. If proximity to high voltage conductors cannot be avoided, use stranded, twisted pair of shield design wire. Ensure that only one end of the shielding is grounded.

Versatronik 515 Dial Setting Overview

Rotary Dial Setting

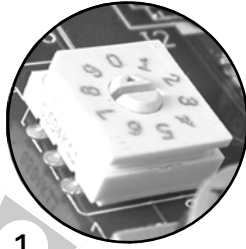

Setting Overview

1. The rotary dial setting on the Versatronik Gateways provides addressing information for systems that may utilize a number of Versatronik Gateways.

It is not required to make adjustments to the rotary dial setting. It should be left in the factory default position setting of 0.

Applications what utilize multiple 515 Gateways may require special settings to avoid duplication of LON addressing.

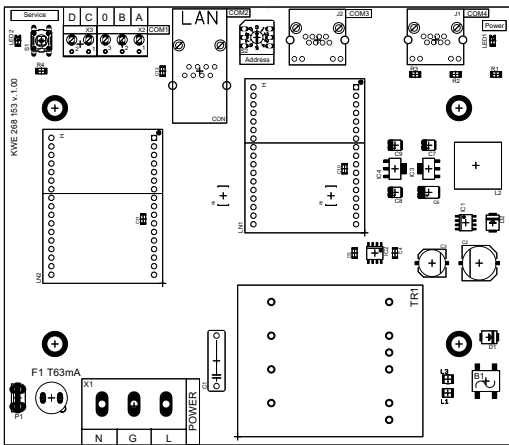

Connection Overview—120VAC

Communication connections—Vitotronic 100, GC1/GC1B, 300 GW2 or 300 GW5B
BACnet IP

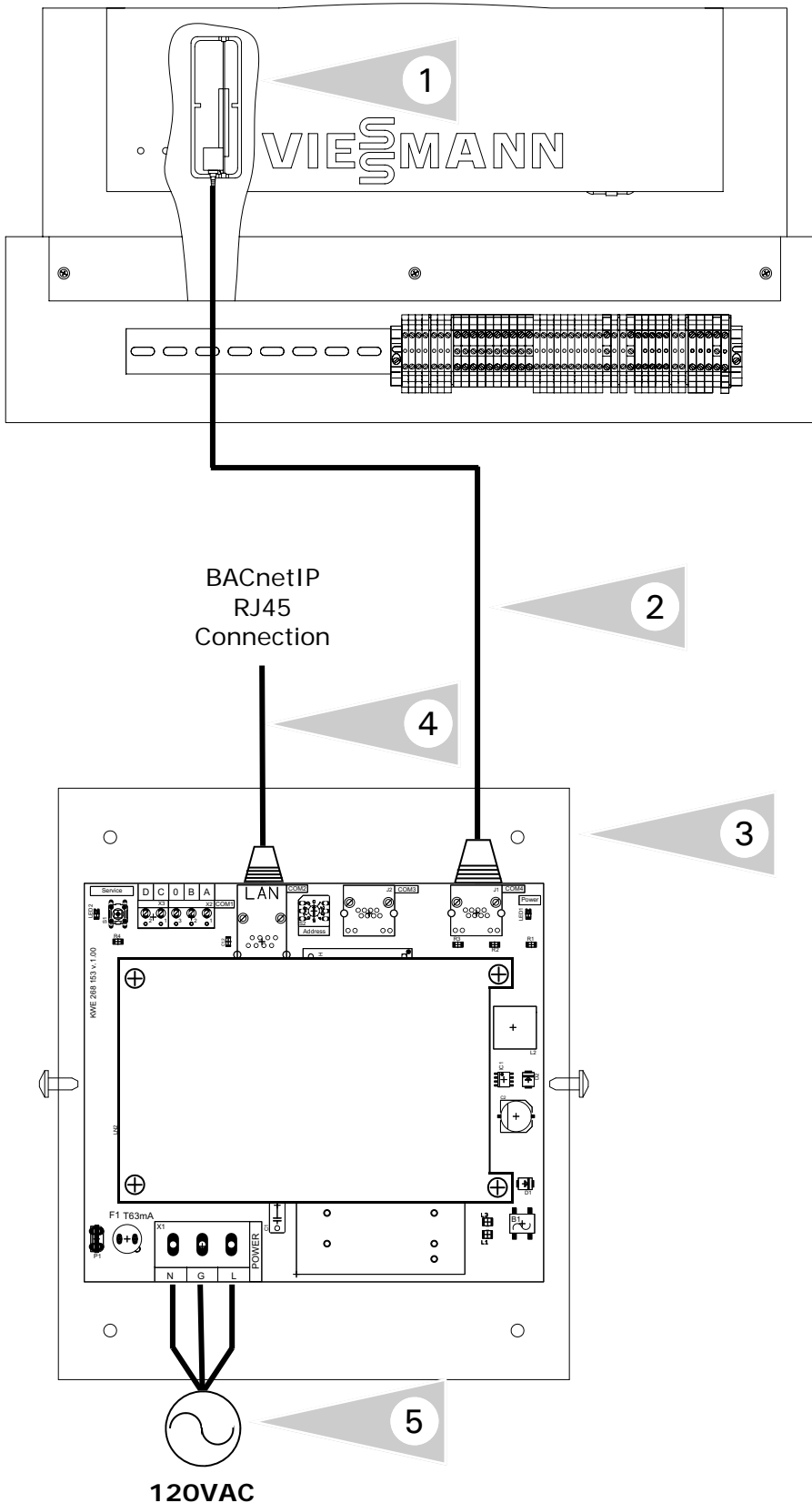

Connection Overview

Refer to manual specific to boiler control. Ensure necessary LON communication card installed.

- 1 Control showing location of LON card and its location within.
- 2 A 3'/91cm CAT-5 cable is supplied with the gateway. The RJ45 is plugged into the control and terminates into the RJ45 socket inside of the Versatronic 515 gateway.
- 3 Versatronic 515 gateway.
- 4 The RJ45 BACnetIP communication connection plugged into Versatronic 515 gateway.
- 5 Plug-in power cord for 120VAC Versatronic 515 gateways.

Connection Overview—24VAC

Communication connections—Vitotronic 100, GC1/GC1B, 300 GW2 or 300 GW5B
BACnet IP

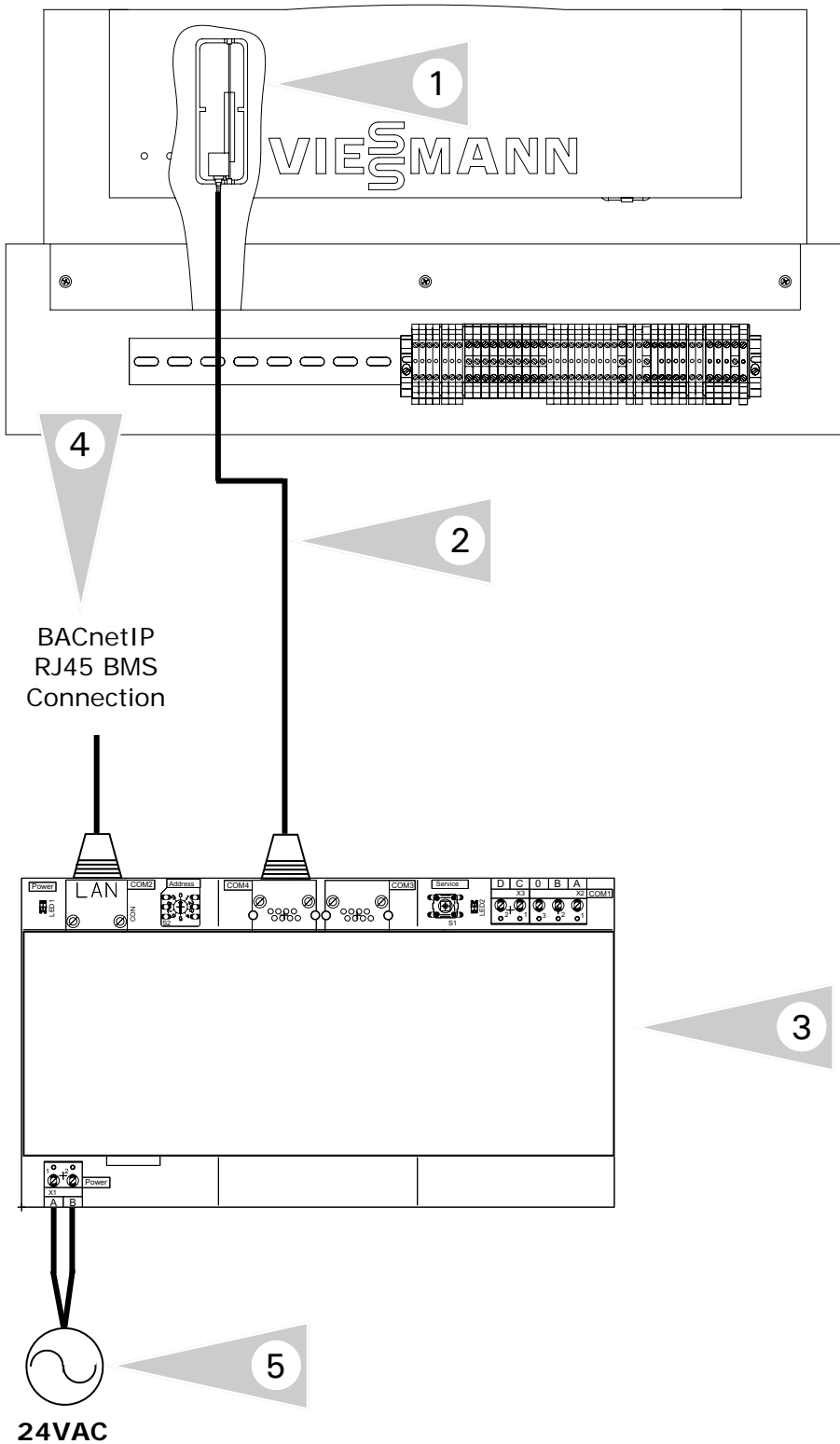

Connection Overview

Refer to manual specific to boiler/system control. Ensure necessary LON communication card installed.

- 1 Control showing location of LON card and its location within.
- 2 A 3'/91cm CAT-5 cable is supplied with the gateway. The RJ45 is plugged into the control and terminates into the RJ45 socket inside of the Versatronik 515 gateway.
- 3 Versatronik 515 gateway.
- 4 The RJ45 BACnetIP communication connection plugged into Versatronik 515 gateway.
- 5 Field supplied 24VAC power supply for gateway.

Connection Overview—120VAC

Communication connections—Vitotronic 100, GC1/GC1B, 300 GW2 or 300 GW5B
BACnet IP

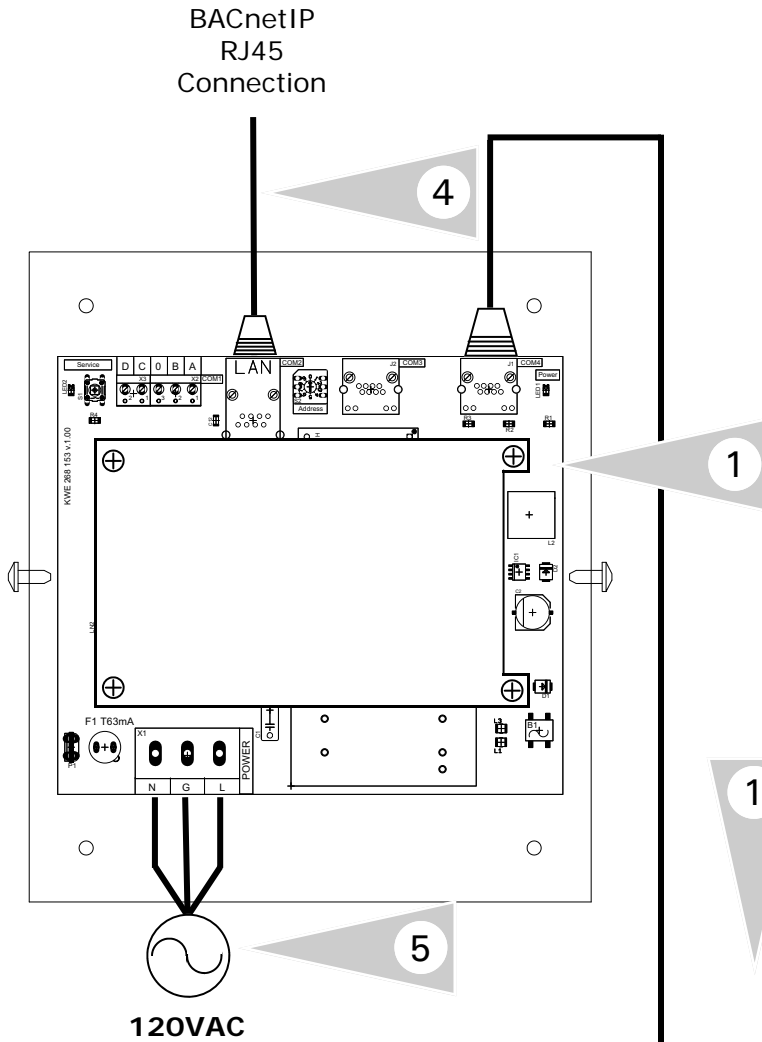

Connection Overview

Refer to manual specific to boiler/
system control. Ensure necessary LON
communication card installed.

- 1 A 3/91cm CAT-5 cable is supplied with the gateway. The RJ45 is plugged into the control and terminates into the RJ45 socket inside of the Versatronik 515 gateway. Vitocontrol-S will need LON card installed.
- 2 Versatronik 515 gateway.
- 3 Field wiring for LON connection to terminals A and B.
- 4 The RJ45 BACnetIP communication connection plugged into Versatronik 515 gateway.
- 5 Plug-in power cord for 120VAC Versatronik 515 gateways.



Connection Overview—24VAC

Communication connections—Vitotronic 100, GC1/GC1B, 300 GW2 or 300 GW5B
BACnet IP

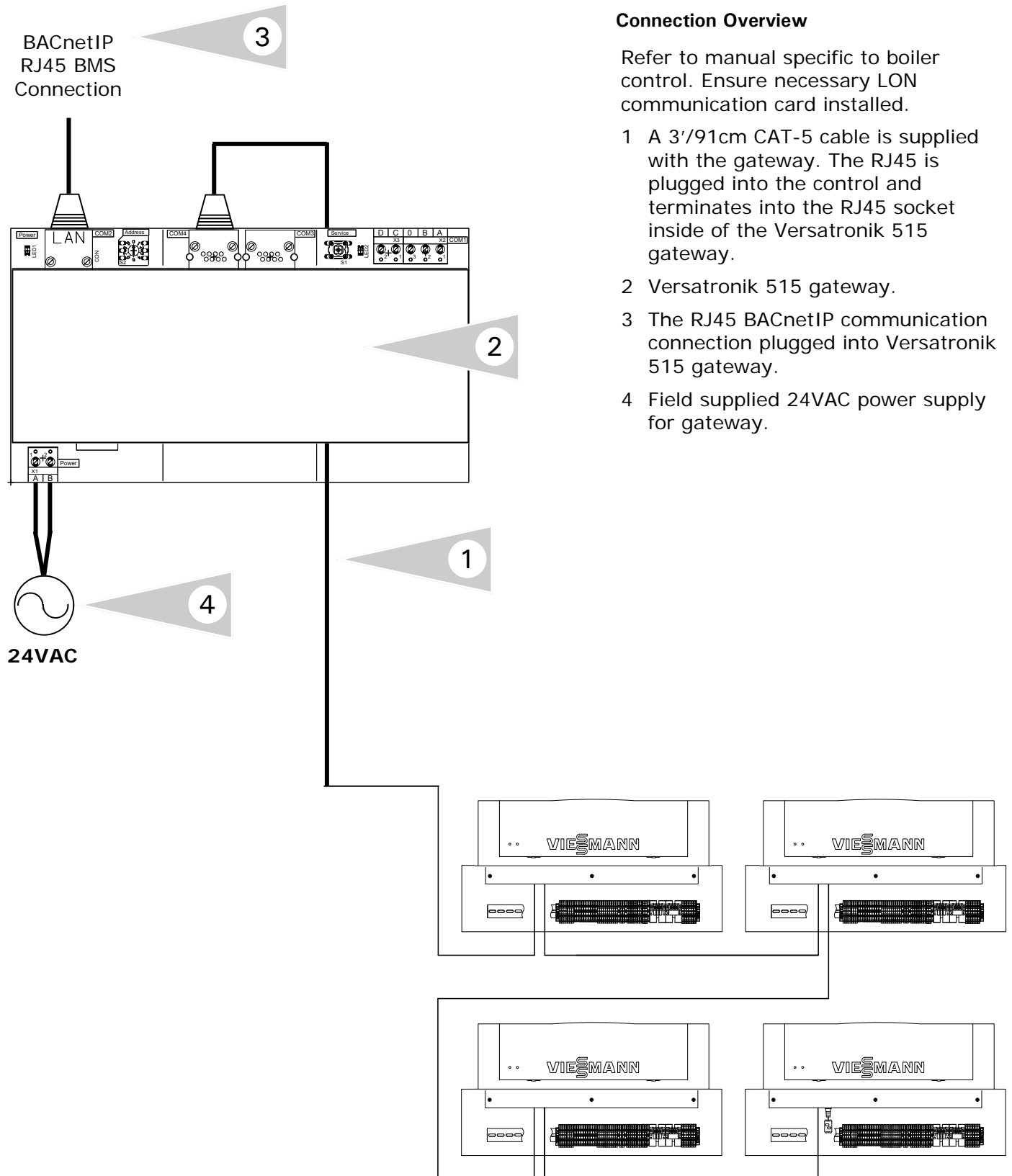

Connection Overview

Refer to manual specific to boiler control. Ensure necessary LON communication card installed.

- 1 A 3'/91cm CAT-5 cable is supplied with the gateway. The RJ45 is plugged into the control and terminates into the RJ45 socket inside of the Versatronic 515 gateway.
- 2 Versatronic 515 gateway.
- 3 The RJ45 BACnetIP communication connection plugged into Versatronic 515 gateway.
- 4 Field supplied 24VAC power supply for gateway.

Connection Overview—120VAC

Communication connections—Vitodens 200, WB2B HO1 or B2HA
BACnetIP

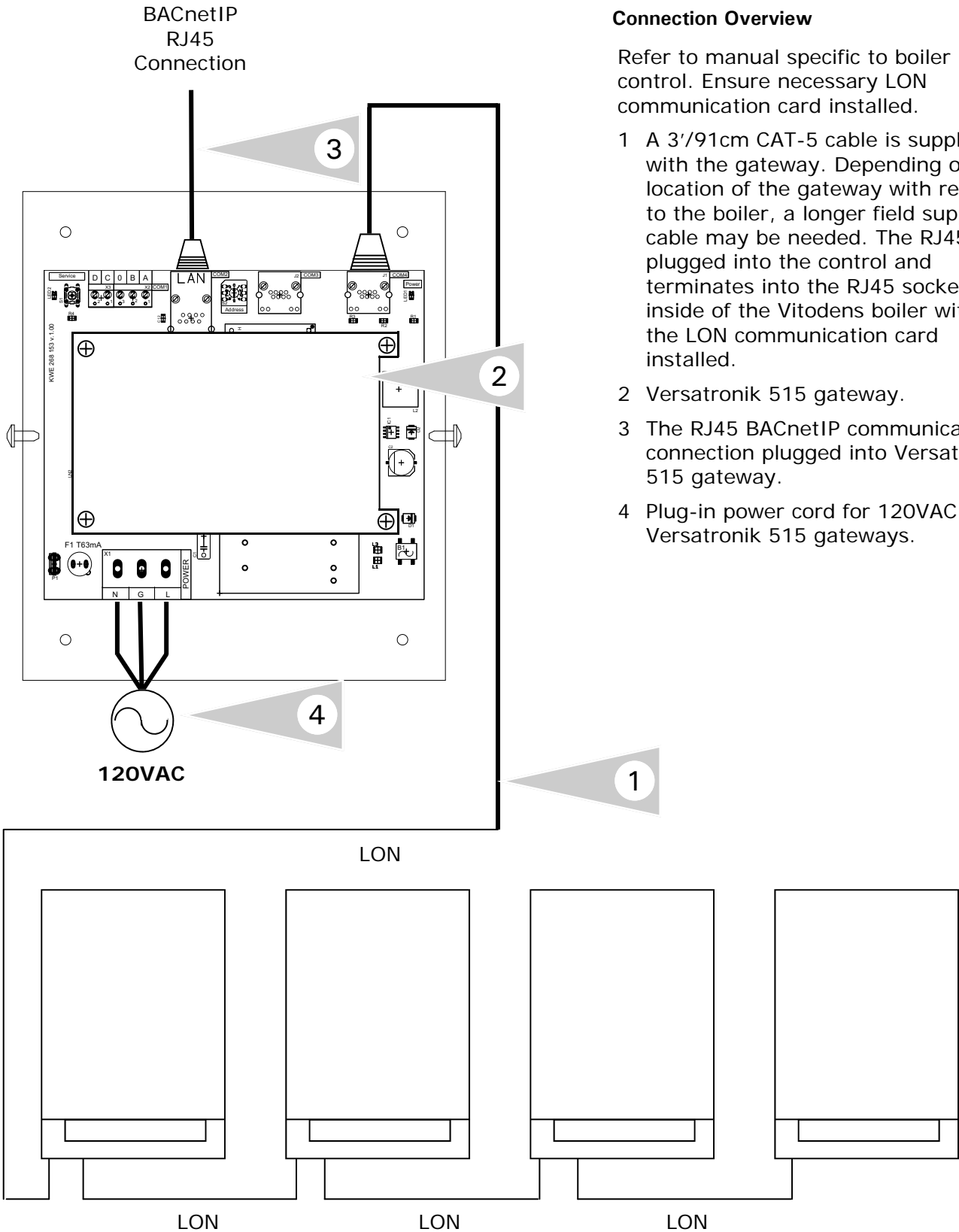

Connection Overview

Refer to manual specific to boiler control. Ensure necessary LON communication card installed.

- 1 A 3’/91cm CAT-5 cable is supplied with the gateway. Depending on the location of the gateway with respect to the boiler, a longer field supplied cable may be needed. The RJ45 is plugged into the control and terminates into the RJ45 socket inside of the Vitodens boiler with the LON communication card installed.
- 2 Versatronik 515 gateway.
- 3 The RJ45 BACnetIP communication connection plugged into Versatronik 515 gateway.
- 4 Plug-in power cord for 120VAC Versatronik 515 gateways.

Connection Overview—24VAC

Communication connections—Vitodens 200, WB2B HO1 or B2HA
BACnetIP

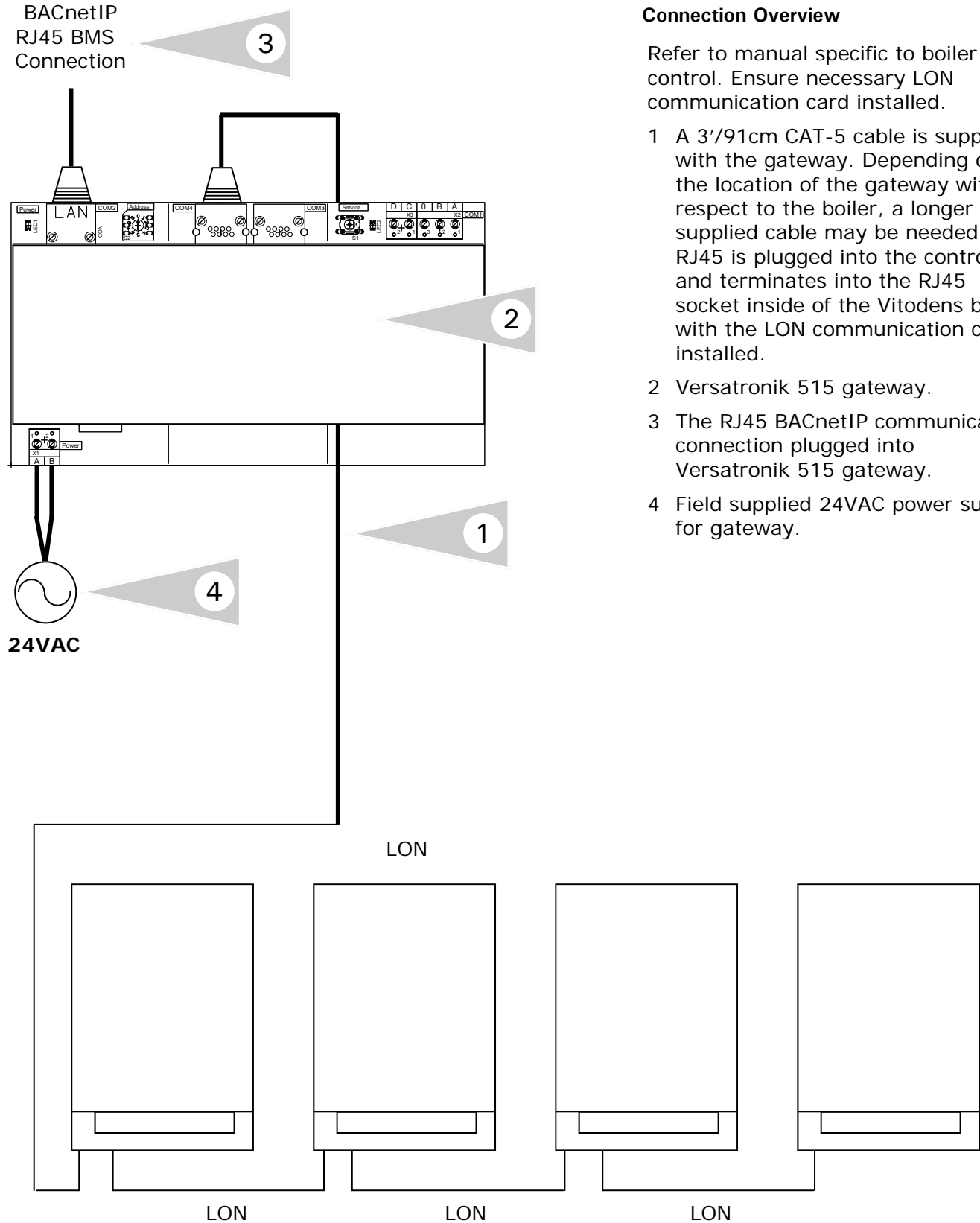

Connection Overview

Refer to manual specific to boiler control. Ensure necessary LON communication card installed.

- 1 A 3'/91cm CAT-5 cable is supplied with the gateway. Depending on the location of the gateway with respect to the boiler, a longer field supplied cable may be needed. The RJ45 is plugged into the control and terminates into the RJ45 socket inside of the Vitodens boiler with the LON communication card installed.
- 2 Versatronik 515 gateway.
- 3 The RJ45 BACnetIP communication connection plugged into Versatronik 515 gateway.
- 4 Field supplied 24VAC power supply for gateway.

Configuration of Gateway

Configuring BACnet/IP Settings

Connect your computer DIRECTLY to the BACnet interface of the gateway device. With no other devices attached (an isolated network). Either set your computer's network connection to automatic IP Address (DHCP), or set your computer's IP address to 192.168.88.90 (subnet mask 255.255.255.0)

Restart the Gateway by cycling the power off and then on again.

Open a browser window and insert the following

URL: <http://192.168.88.89/admin>

The default user name / password is "admin" and "admin" (without the quotes). This can be renamed in the Change Password screen. At this point you will see the Configuration pages.

Versatronik 515 NR2/BACIP

<ul style="list-style-type: none">HomeBACnet/IP SettingsBACnet Device SettingsAdvanced SettingsRestore DefaultsChange PasswordActivate Configuration	<h4>BACnet/IP Settings</h4> <p>This page allows you to view current BACnet/IP settings, to change them or to restore them to factory defaults.</p> <table border="1"><thead><tr><th>Parameter</th><th>Value</th><th>Description</th></tr></thead><tbody><tr><td>IP</td><td><input type="text" value="192.168.0.22"/></td><td>IP address of the BACnet device.</td></tr><tr><td>Network Mask</td><td><input type="text" value="255.255.255.0"/></td><td>IP subnet mask.</td></tr><tr><td>Default Gateway</td><td><input type="text" value="192.168.0.1"/></td><td>IP address of the default gateway.</td></tr><tr><td>UDP Port</td><td><input type="text" value="47808"/></td><td>BACnet/IP UDP port number.</td></tr></tbody></table> <p><input type="button" value="Save"/> <input type="button" value="Reset"/> <input type="button" value="Defaults"/></p>	Parameter	Value	Description	IP	<input type="text" value="192.168.0.22"/>	IP address of the BACnet device.	Network Mask	<input type="text" value="255.255.255.0"/>	IP subnet mask.	Default Gateway	<input type="text" value="192.168.0.1"/>	IP address of the default gateway.	UDP Port	<input type="text" value="47808"/>	BACnet/IP UDP port number.
Parameter	Value	Description														
IP	<input type="text" value="192.168.0.22"/>	IP address of the BACnet device.														
Network Mask	<input type="text" value="255.255.255.0"/>	IP subnet mask.														
Default Gateway	<input type="text" value="192.168.0.1"/>	IP address of the default gateway.														
UDP Port	<input type="text" value="47808"/>	BACnet/IP UDP port number.														
Copyright © 2006-2007 Cimetrics	v1.2 (EX-28m-b7092-1.2)															

IMPORTANT: Make sure that you remember any changes made here.

Configuration of Gateway Continued

BACnet Device Settings

You can now reconfigure these settings according to your network requirements. Make sure that you press SAVE on every screen where you make changes. The new setting will not take effect until the Activate Configuration screen has been confirmed. These configuration pages can now be accessed through both the 192.168.88.89 Address, as well as the one you have selected.

The BACnet Device Settings screen looks like this:

Versatronik 515 NR2/BACIP

- Home
- BACnet IP Settings
- BACnet Device Settings**
- Advanced Settings
- Restore Defaults
- Change Password
- Activate Configuration

BACnet Device Settings

This page allows you to view current BACnet Device settings, to change them or to restore them to factory defaults.

Parameter	Value	Description
Device ID:	<input type="text" value="1"/>	BACnet Device Instance Number.
Object Name:	<input type="text"/>	Value of the Device's Object_Name property.
Description:	<input type="text"/>	Value of the Device's Device_Description property.
Location:	<input type="text"/>	Value of the Device's Device_Location property.

Copyright © 2006-2007 Cimetrics v1.2 (EX-28m-b7092-1.2)

NOTE: The **Device ID** must be unique on the entire BACnet internetwork.

The Restore Defaults and Change Password screens are very simplistic. When you select Activate Configuration, it will ask you if you want to SAVE your settings. This will then store your new settings and reboot automatically.

You can now join the Gateway to the rest of your network, provided you have not specified a duplicate IP Address. Any Computer on the network should now be able to access these configuration screens.

Configuration of Gateway Continued BACnet IP Type B

Configuration and Control

The Versatronik 515 NR2 / BACIP Type-B gateway has to be configured with the participant numbers (Node IDs) of the NR2 boiler controls. The addresses for boilers 1 through 16 should be entered in AO1-16.

When controlling the boilers special attention needs to be given to the Command State (A03xx_); you can either control the boilers based on a modulation % (Boiler On), or a temperature set point (Auto Mode.)

Note: Status Light Operation
 Flashing=communication
 ON Solid or Off=no communication

Analogue Input Network Variables

Point	Point Description	Unit	Details
AI1-16	Boiler 1-16 Fault	N/A	See alarm Appendix A
AI101-116	Boiler 1-16 Relay State	N/A	Bit[0] = Burner Fault Bit[1] = Burner 1st Stage Bit[3] = Boiler Pump
AI201-216	Boiler 1-16 Effective Set Point	N/A	
AI301-316	Boiler 1-16 Supply Temperature	N/A	
AI401-416	Boiler 1-16 State	%	

Analogue Output Network Variables

Point	Point Description	Unit	Details
AO1-16	Boiler 1-16 Address	N/A	Participant number (Node ID, Address 77)
AO101-116	Boiler 1-16 Set Point	N/A	Minimum Set point (Command state = Auto)
AO201-216	Boiler 1-16 Command Value	%	Minimum Output (Command state = Boiler On)
AO301-316	Boiler 1-16 Command State	N/A	0 = Boiler Off 1 = Boiler On —Boiler runs based on Command Value -1 (0xFF) = Auto Mode —Boiler runs based on Set Point
AO400	Units	N/A	Unit settings – 0 = °C, 1 = °F

Fault Codes

Appendix A—Fault Codes

Error codes for Viessmann control units based on controls/equipment installed

Fault Code (hex)	Fault Code (Dec)	Description
00	00	System without fault
0F	15	Perform maintenance check-up
10	16	Short circuit, outdoor temperature sensor
18	24	Interruption, outdoor temperature sensor
20	32	Short circuit, supply temperature sensor HC1/system
28	40	Interruption, supply temperature sensor HC1/system
30	48	Short circuit, boiler water temperature sensor
38	56	Interruption, boiler water temperature sensor
40	64	Short circuit, supply temperature sensor heating circuit 2
41	65	Short circuit, return temperature sensor heating circuit 2
44	68	Short circuit, supply temperature sensor heating circuit 3
45	69	Short circuit, return temperature sensor heating circuit 3
48	72	Interruption, supply temperature sensor heating circuit 2
49	73	Interruption, return temperature sensor heating circuit 2
4C	76	Interruption, supply temperature sensor heating circuit 3
4d	77	Interruption, return temperature sensor heating circuit 3
50	80	Short circuit, DHW tank temperature sensor
51	81	Short circuit, DHW tank temperature sensor 2
58	88	Interruption, DHW tank temperature sensor
59	89	Interruption, DHW tank temperature sensor 2
60	96	Short circuit, return temperature sensor 17
68	104	Interruption, return temperature sensor 17
70	112	Short circuit, supply/return temperature sensor 17B
78	120	Interruption, supply/return temperature sensor 17B
92	146	Solar: collector temperature short circuit
93	147	Solar: collector return temperature short circuit
94	148	Solar: collector DHW tank temperature sensor short circuit
9A	154	Solar: collector temperature sensor open circuit
9B	155	Solar collector return temperature sensor open circuit
9C	156	Solar: DHW tank temperature sensor open circuit
9F	159	Solar: general fault message
A7	167	Fault control unit wireless clock module
AE	174	Internal fault mixing valve
AF	175	Internal fault mixing valve
b0	176	Short circuit, flue gas temperature sensor
b1	177	Communication fault, programming unit (internal)
b4	180	Internal fault
b5	181	Internal fault
b6	182	Internal fault, invalid hardware recognition
b7	183	Internal fault, boiler protection coding card
b8	184	Interruption, flue gas temperature sensor
bA	186	Fault, mixing valve module (KM-BUS)
bC	188	Fault, Vitotrol heating circuit 1 (KM-BUS)
bd	186	Fault, Vitotrol heating circuit 2 (KM-BUS)
bE	190	Fault, Vitotrol heating circuit 3 (KM-BUS)
C1	193	External fault indication, boiler
C2	194	Communication fault solar control unit (KM-BUS)

Fault Codes Continued

Appendix A—Fault Codes Continued

Error codes for Viessmann control units based on controls/equipment installed

Fault Code (hex)	Fault Code (Dec)	Description
C5	197	Fault, speed controlled pump heating circuit 1 (KM-BUS)
C6	198	Fault, speed controlled pump heating circuit 2 (KM-BUS)
C7	199	Fault, speed controlled pump heating circuit 3 (KM-BUS)
C8	200	Fault, water level control
C9	201	Fault, maximum pressure
CA	202	Fault, minimum pressure/maximum pressure 2
Cb	203	Fault, maximum pressure 2
CC	204	Reserved, external periphery
Cd	205	Communication fault, Vitocom 300 (KM-BUS)
CE	206	Communication fault, fault indicator module (KM-BUS)
CF	207	Communication fault: wrong LON module
d1	209	Burner fault, boiler
d4	212	Fixed high limit fault, boiler
d5	213	Cascade: boiler is not responding
d6	214	External fault 1, plug-in adaptor
d7	215	External fault 2, plug-in adaptor
d8	216	External fault 3, plug-in adaptor
dA	218	Short circuit, room temperature sensor heating circuit 1
db	219	Short circuit, room temperature sensor heating circuit 2
dC	220	Short circuit, room temperature sensor heating circuit 3
dd	221	Interruption, room temperature sensor heating circuit 1
dE	222	Interruption, room temperature sensor heating circuit 2
dF	223	Interruption, room temperature sensor heating circuit 3
E0	224	Fault, external participant/device connected to LON
E4	228	Fault power supply voltage
E5	229	Internal fault combustion control unit
E6	230	Flue gas/air supply system blocked
F0	240	Communication fault combustion control unit
F1	241	Flue gas temperature limit has tripped
F2	242	Temperature limit has tripped
F3	243	Flame signal is present at burner start
F4	244	Flame signal is not present
F5	245	Air pressure switch not open for burner start
F6	246	Gas pressure switch not open for burner start
F7	247	Air pressure sensor short circuit or offset value outside of tolerances
F8	248	Fuel valve closure delayed
F9	249	Blower speed too low at burner start
FA	250	Blower speed too high at burner start
FC	252	Control of modulation valve defective
FD	253	Fault combustion control unit
FE	254	Coding plug defective or wrong EMV error
FF	255	Internal fault

Additional Alarm/Fault Information

Viessmann controls show fault codes in hexadecimal format to conserve screen space on the user interface of the boiler and system controls. The Versatronik 515 gateway uses a SNVT_count variable which is usually displayed in decimal format.

The base-format in which this fault can be displayed depends on your BMS software. This example shows how to display this fault code in hexadecimal, and Text format in Niagara AX.

To display in hex, you can use the KitControl -> Util "Numeric Bit And" object's mask input.

To display the equivalent fault text value, you can use the KitControl -> Conversion "Numeric To Enum" object and type out the enum range for all Viessmann error codes.

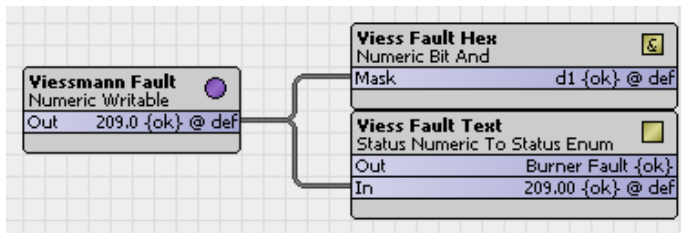

These values can now be displayed on a px webpage by pointing a Bound Label to the appropriate slot values.

Fault Code: d1 (Burner Fault)

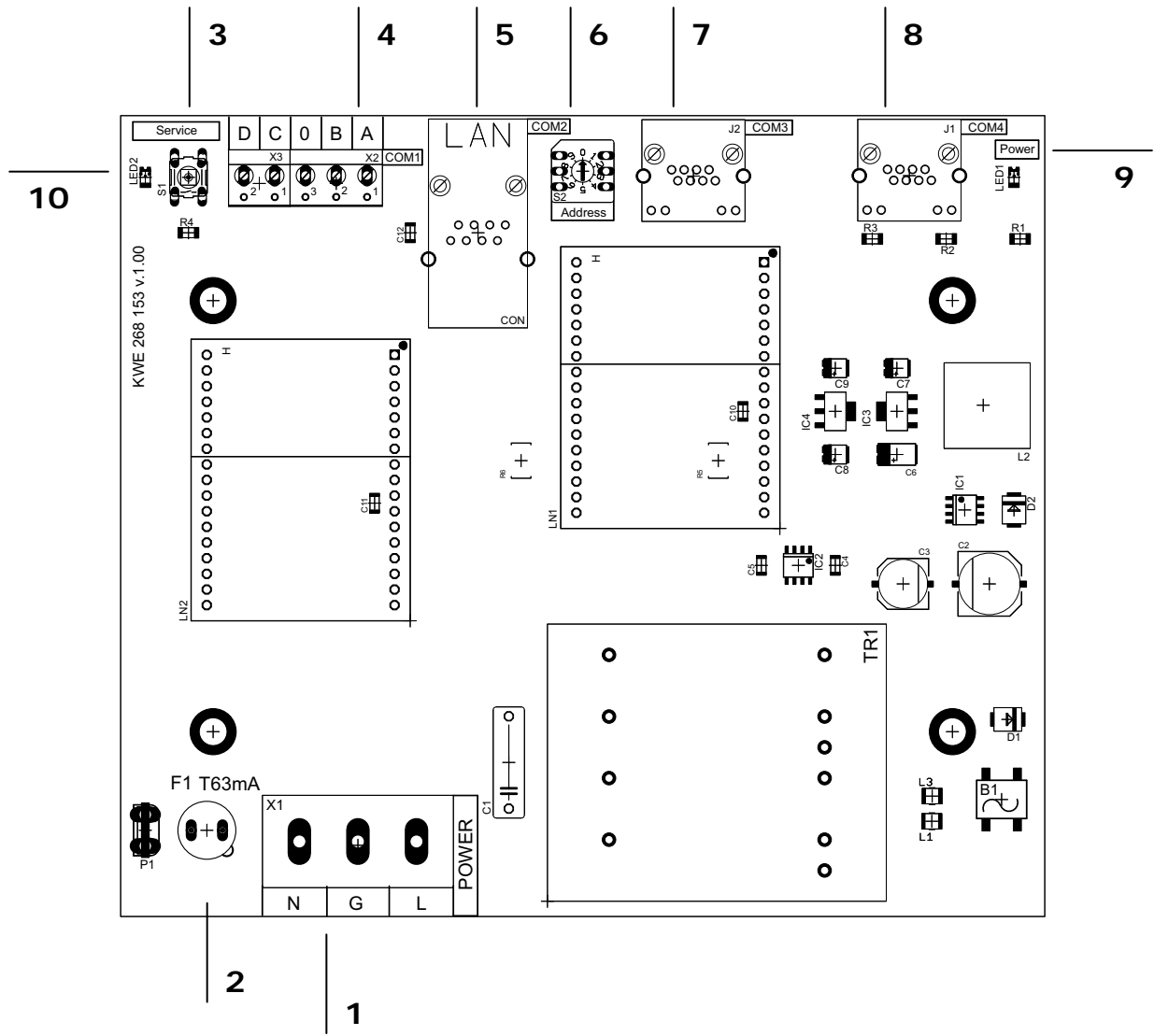

PCB Identifiers

1	120VAC Power Supply Connections
2	Fuse
3	Service Button
4	LON Connections to BMS
5	RJ45 Connection to BMS BACnet
6	Addressing selector for multiple modules
7	COM3 for multiple BUS connections
8	COM4 RJ45 Connection to control
9	Power LED indicator
10	Service LED

Specifications

Voltage Requirements	120VAC
Fuse Rating	80mA Time Delay
Power	4VA
Communication Connections	Supplied cable between devices

CAUTION

Static sensitive components may be damaged by improper handling or work within the control. Ensure all possible measures are taken to eliminate build-up of static electricity.

KWE P/N 394045 Versatronik 515 and 515D BACIP Type B Gateway V1.1 Feb 2014 Technical information subject to change without notice

Technical Information

KWE P/N 394045 Versatronic 515 and 515D BACIP Type B Gateway V1.1 Feb 2014 Technical information subject to change without notice

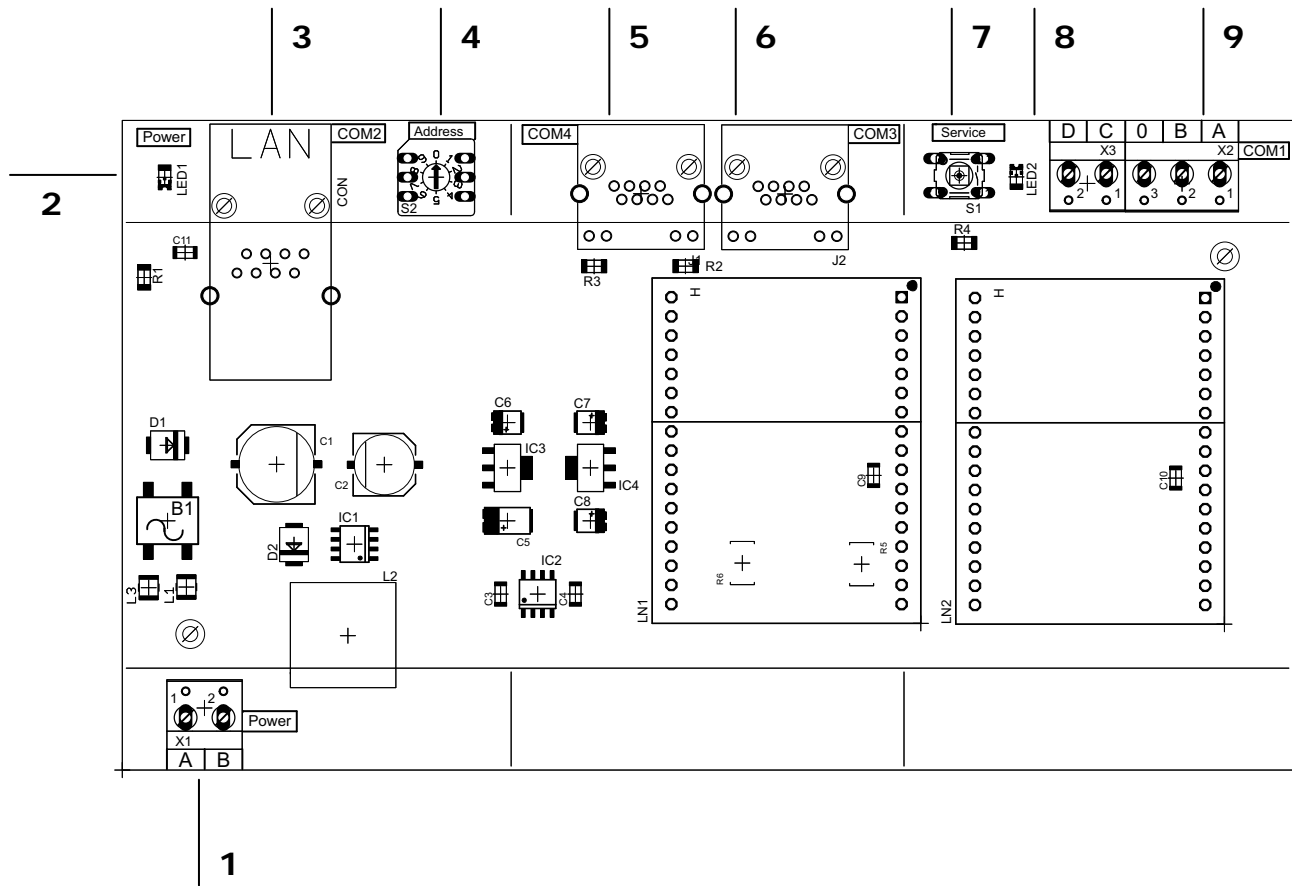

PCB Identifiers

1	24VAC Power Supply Connections
2	Power LED indicator
3	BACnet RJ45 BMS Connection
4	Addressing dial for multiple units
5	COM4 RJ45 Connection to control
6	COM3 for multiple BUS connections
7	Service button
8	Service LED
9	LON Connections to BMS

Specifications

Voltage Requirements	24VAC
Fuse Rating	N/A
Power	4VA
Communication Connections	Supplied cable between devices



CAUTION

Static sensitive components may be damaged by improper handling or work within the control. Ensure all possible measures are taken to eliminate build-up of static electricity.

KWE Technologies Group
750 McMurray Road
Waterloo, Ontario, Canada
N2V 2G5
Tel: (519) 747-5042
Fax: (519) 747-4448
www.kwe-tech.com
info@kwe-tech.com

