

Versatronik® 535 & 535D Solar

Communication Gateway for solar controls
BACnet IP



Document Applicable to:
Versatronik 535 Solar/BACIP Wall Mount 704065
Versatronik 535D Solar/BACIP DIN Rail Mount 704066

- Applicable Controls**
- Resol Deltasol M
 - Resol Deltasol BS Plus
 - Resol Deltasol BS1/2/3/4
 - Resol Deltasol BX/BXL
 - Resol Deltasol E/ES/BX/MX/SKSC3
 - Viessmann Vitosolic 200
 - Viessmann SCU 124
 - Viessmann SCU 224
 - Viessmann SCU 345

Technical, Installation and Configuration Information

Cautionary Statement

The information presented in this document is only to be used by those familiar with its application and use.



C US LR 102874

IMPORTANT

Read and save these instructions for future reference

About these instructions



Take note of all symbols and notations intended to draw attention to potential hazards or important product information. These include "WARNING", "CAUTION" and "IMPORTANT". See below.



WARNING

Indicates an imminently hazardous situation which, if not avoided, could result in death, serious injury or substantial product/property damage.

→ Warnings draw your attention to the presence of potential hazards or important product information.



CAUTION

Indicates an imminently hazardous situation which, if not avoided, may result in minor injury or product/property damage.

→ Cautions draw your attention to the presence of potential hazards or important product information



CAUTION

Static sensitive components may be damaged by improper handling or work within the control. Ensure all possible measures are taken to eliminate build-up of static electricity.

→ Helpful hints for installation, operation or maintenance which pertains to the product.

IMPORTANT

Trademark Information

RESOL® and DeltaSol® M are trademarks of RESOL.

For more information please visit www.resol-gmbh.de

Viessmann® and Vitotronic® are trademarks of Viessmann Werke GmbH & Co KG registered in the United States and other countries.

Please visit:
www.viessmann.ca
www.viessmann.us



BACnet® is a registered trademark of the American Society of Heating, Refrigerating and Air-Conditioning Engineers, Inc., 1791 Tullie Circle NE, Atlanta, GA 30329.

For more information please visit:
www.bacnet.org
www.ashrea.org

Important Regulatory and Installation Requirements

Codes

The installation of this unit must be in accordance with local codes.

→ Please carefully read this manual prior to attempting installation. Any warranty is null and void if these instructions are not followed.

All electrical wiring is to be done in accordance with the latest edition of CSA C22,1 Part 1 and/ or local codes. In the U.S. use the National Electrical Code ANSI/NFPA 70.

→ The completeness and functionality of field supplied electrical controls and components must be verified by those installing the device

The installing contractor must comply with the Standard of Controls and Safety Devices for Automatically fired Boilers, ANSI/ASME CSD-1 where required by the authority having jurisdiction.

Working on the equipment

The installation, adjustment, service and maintenance of this unit must be done by a licensed professional heating contractor or persons who are qualified and experienced in the installation, service, and maintenance of similar products. There are no user serviceable parts on this control.

 **WARNING**

More than one live circuit. See wiring diagram in this manual. Turn off power supply to control and damper/blower before servicing. Contact with live electrical components can result in serious injury or death

Power supply

Install power supply in accordance with the regulation of the authorities having jurisdiction or in absence of such requirements, in accordance with National Codes.

Purpose of Device and Operation

The Versatronik 535 Solar gateway provides a communication translation between applicable controls and DDC systems which are capable of BACnet IP communications.

The Versatronik gateway may be either part of a control panel or stand-alone control device.

Installation

Mounting Versatronik Gateway—120VAC Unit

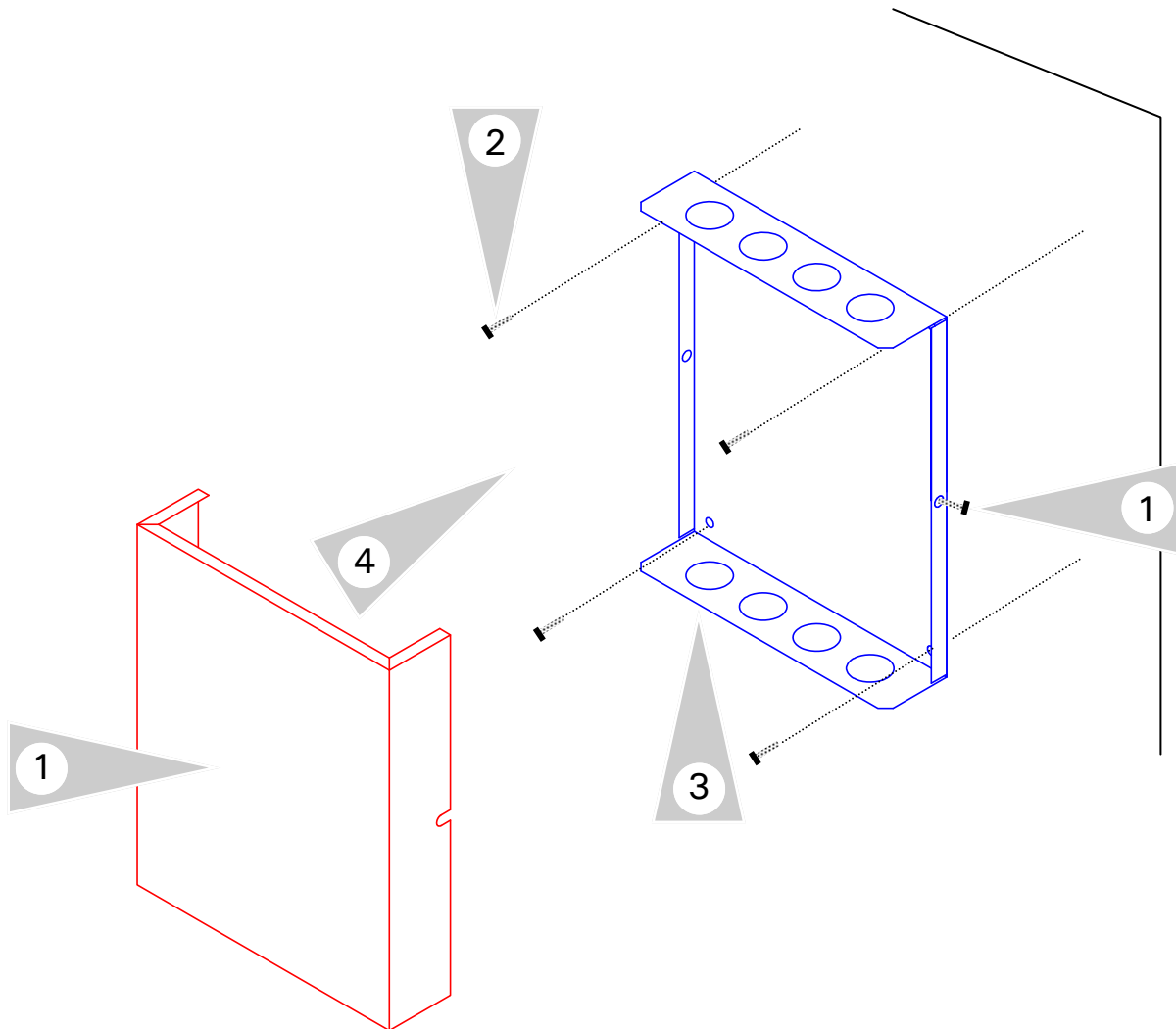

Mounting Steps

1. Mount Versatronik 535 Gateway in a convenient location near the solar control. Remove cover by loosening the two screws on either side of base to release the cover.
2. Fasten base to wall using field-supplied screws/fasteners.
3. Remove knockout and installed wire strain relief or box connector. Removal of remaining knockouts is required to make further connections.
4. Once all of the 120VAC and low voltage connections are complete and verified, reinstall the cover from Step 1.



WARNING

When extending wire there is the possibility of exposure to electromagnetic interference. Avoid running wires beside or near high voltage 120/240 VAC conductors. If proximity to high voltage conductors cannot be avoided, use stranded, twisted pair of shield design wire. Ensure that only one end of the shielding is grounded.

Installation

Mounting Versatronik Gateway—24VAC DIN Rail Unit

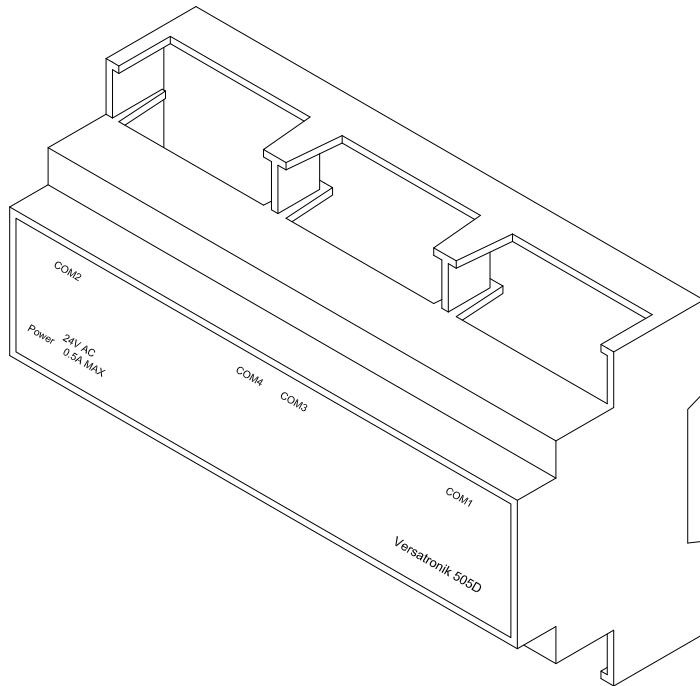

Mounting Steps

1. Mount Versatronik 535D Gateway onto DIN rail within an enclosure in a convenient location near the solar control.
2. Make all the necessary connections including the 24VAC power connection.

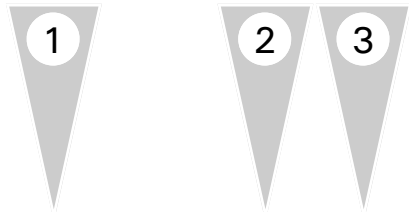

Connection Overview

1. BACnet IP connection.
2. Solar Control Connection RJ45
3. Paralleled BUS connection
4. 24VAC Power Connection

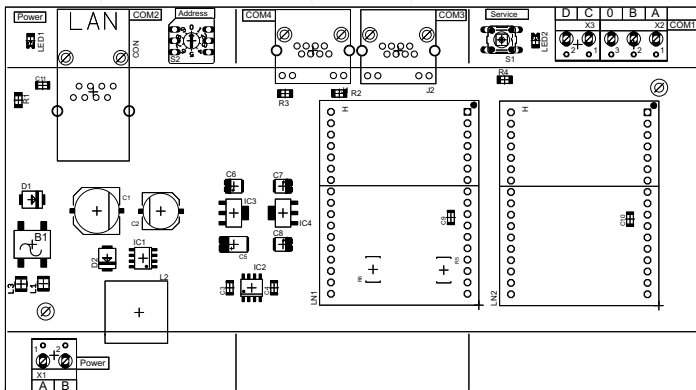

WARNING

When extending wire there is the possibility of exposure to electromagnetic interference. Avoid running wires beside or near high voltage 120/240 VAC conductors. If proximity to high voltage conductors cannot be avoided, use stranded, twisted pair of shield design wire. Ensure that only one end of the shielding is grounded.

Connection Overview

RJ45 Communication Cable Supplied

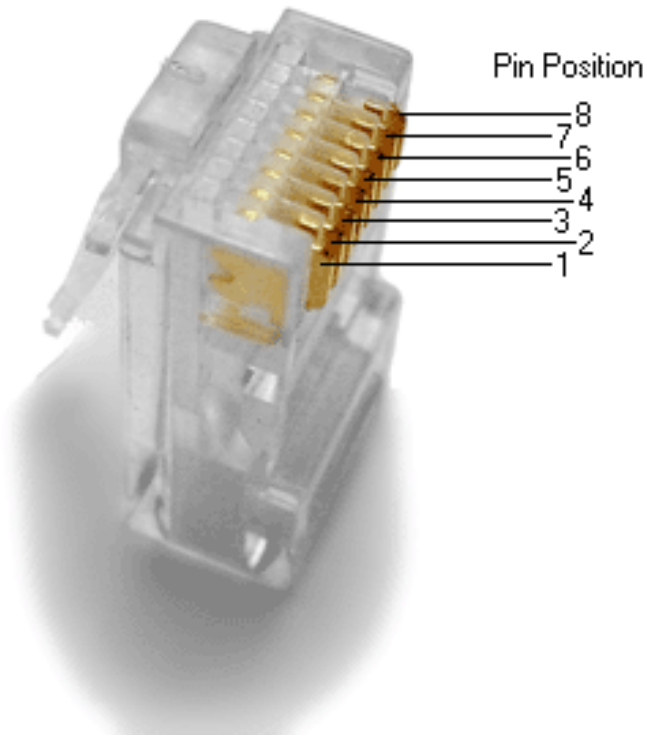

Connection Overview

1. Cut UTP cable to 2m length.
2. Strip insulation and crimp plug on one end.
3. Strip other end, cut all wires but wire 1 and 2.
4. Strip wire 1 and 2.
5. Wires 1 and 2 used to make connections to the solar control.

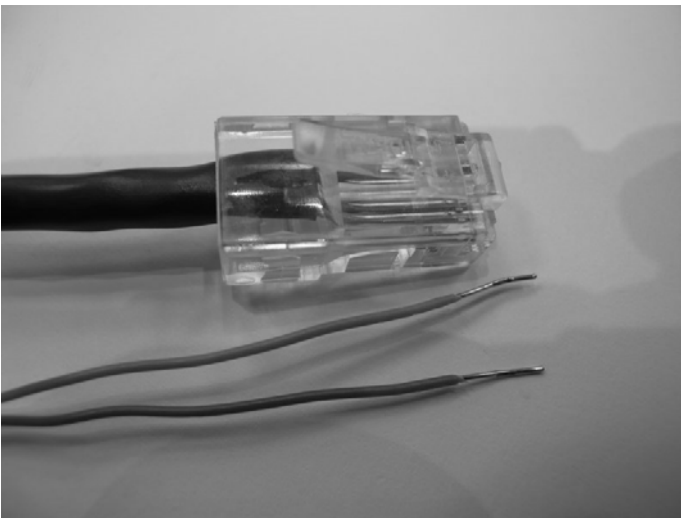

Versatronik 535 Dial Setting Overview

Rotary Dial Setting

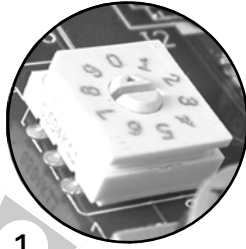

Setting Overview

1. The rotary dial setting on the Versatronik Gateways provides addressing information for systems that may utilize a number of Versatronik Gateways.

Applications with the Versatronik 535 Solar with RESOL controls, it is not required to make adjustments to the rotary dial setting. It should be left in the factory default position setting of 0.

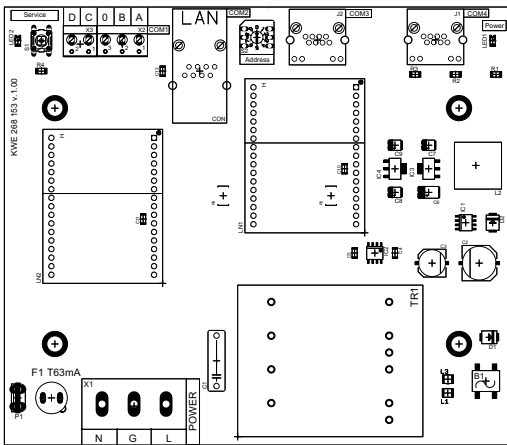

Connection Overview—120VAC Unit

BACnet IP Communication connections to BMS:
 Example: Resol Deltasol BS Plus

1.2 Electrical connection

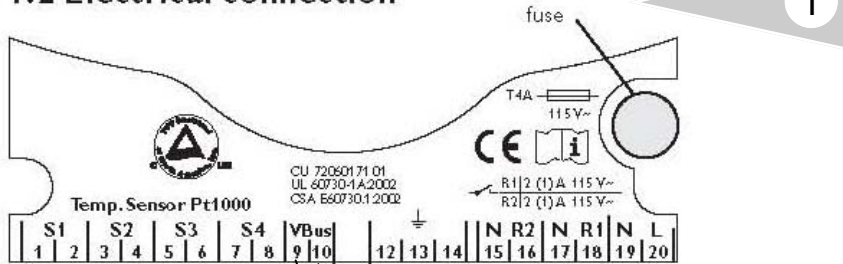

BMS Connection

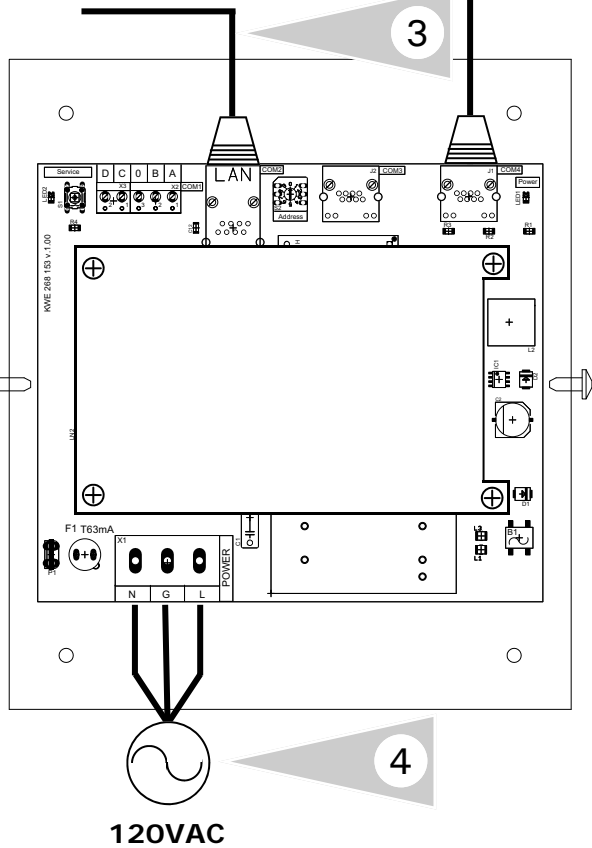

Connection Overview

- 1 Control sensor portion of control.
- 2 A CAT-5 cable is supplied with the Versatronik Solar Gateway. The RJ45 is plugged into the gateway and terminates into the control.
- 3 BMS connection.
- 4 Standard plug-in power connection supply for the gateway. It requires 120VAC for its operation.

Connection Overview—120VAC Unit

BACnet IP Communication Connections to BMS:
Example: Resol Deltasol M

Connection Overview

- 1 Control sensor portion of control.
- 2 A CAT-5 cable is supplied with the Versatronik Solar Gateway. The RJ45 is plugged into the gateway and terminates into the control.
- 3 BMS connection.
- 4 Standard plug-in power connection supply for the gateway. It requires 120VAC for its operation.

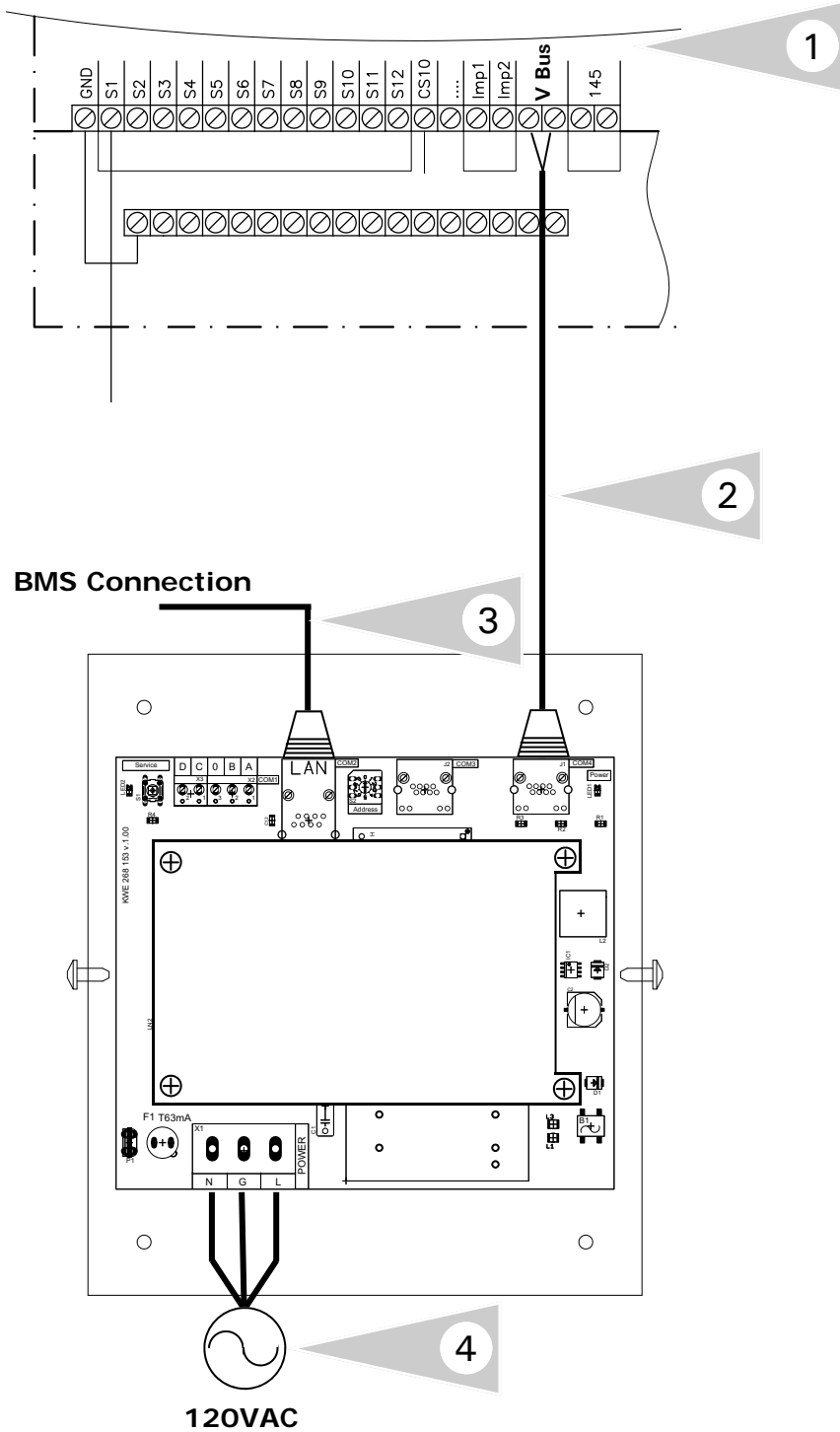

Connection Overview—24VAC DIN Rail Unit

BACnet IP Communication Connections to BMS:
 Example: Resol Deltasol BS Plus

1.2 Electrical connection

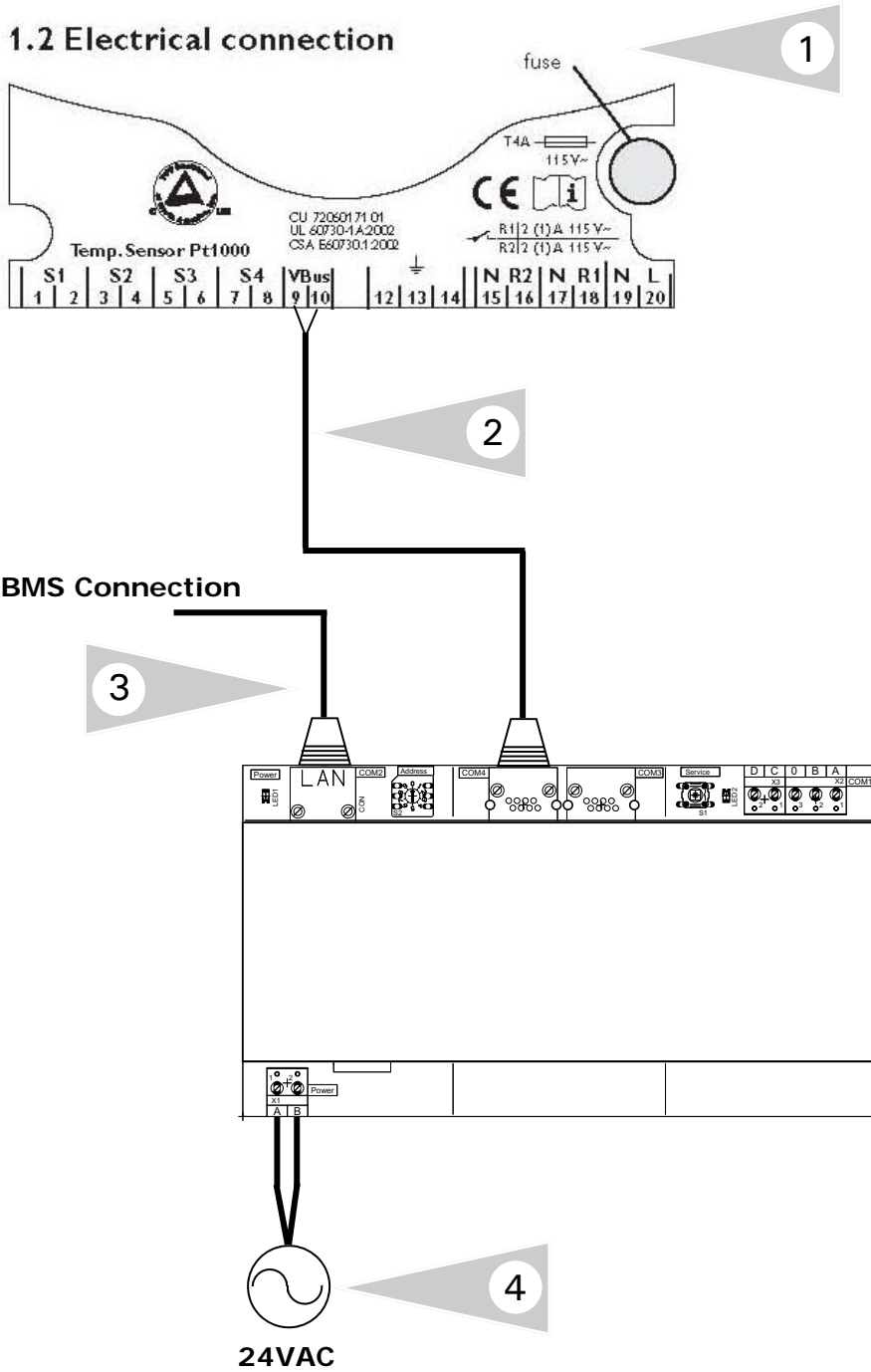

Connection Overview

- 1 Control sensor portion of control.
- 2 A CAT-5 cable is supplied with the Versatronik Solar Gateway. The RJ45 is plugged into the gateway and terminates into the control.
- 3 BMS connection.
- 4 Standard plug-in power connection supply for the gateway. It requires 24VAC for its operation.

Connection Overview—24VAC DIN Rail Unit

BACnet IP Communication Connections to BMS:
 Example: Resol Deltasol M

Connection Overview

- 1 Control sensor portion of control.
- 2 A CAT-5 cable is supplied with the Versatronik Solar Gateway. The RJ45 is plugged into the gateway and terminates into the control.
- 3 BMS connection.
- 4 Standard plug-in power connection supply for the gateway. It requires 24VAC for its operation.

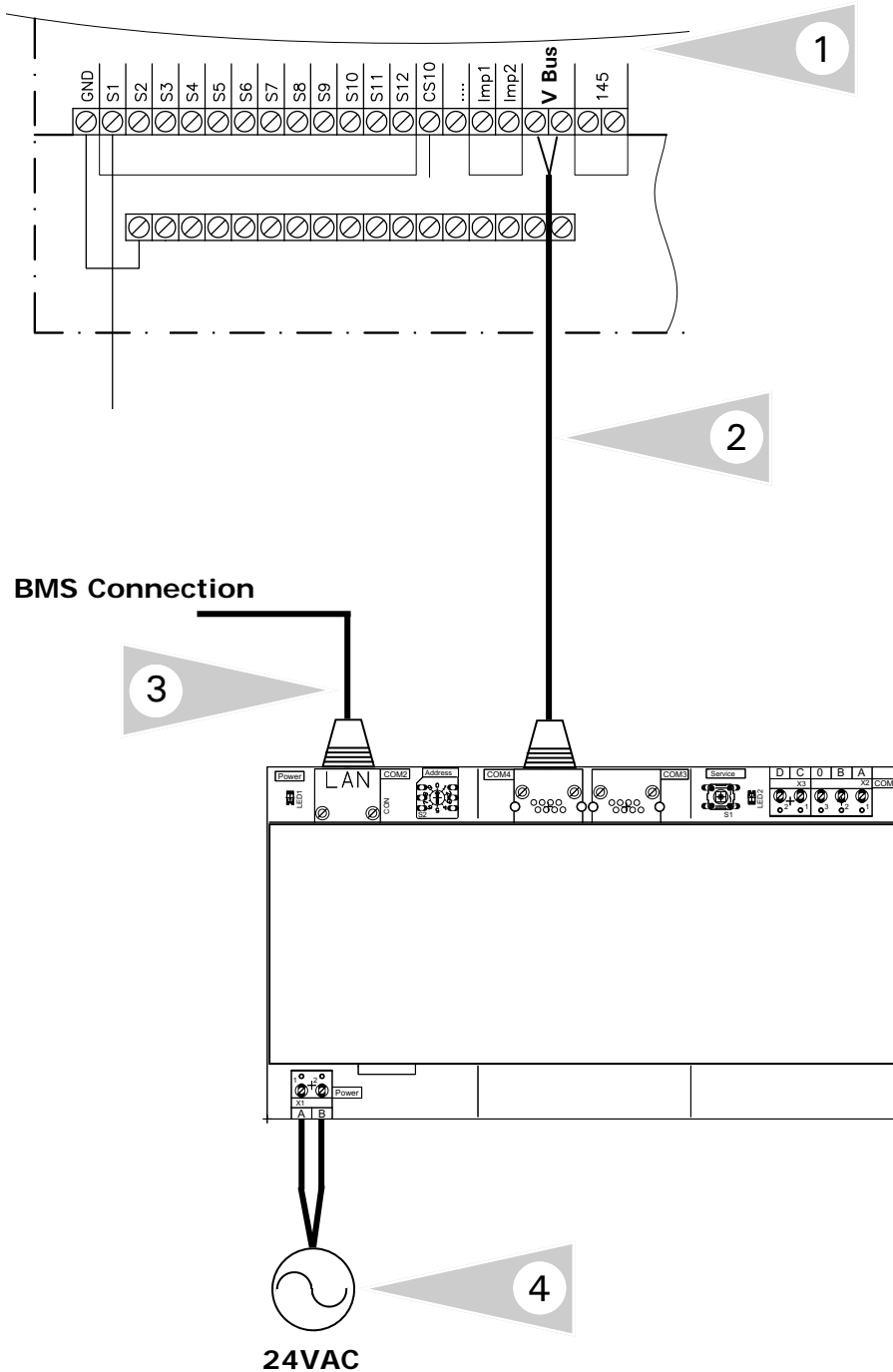

KWE P/N 394043 Versatronik 535 Solar Gateway V1.0 09/2013 Technical information subject to change without notice

Configuration of Gateway

Configuring BACnet/IP Settings

Connect your computer DIRECTLY to the BACnet interface of the gateway device, with no other devices attached (an isolated network). Either set your computer's network connection to automatic IP Address (DHCP), or set your computer's IP address to 192.168.88.90 (subnet mask 255.255.255.0)

Restart the Gateway by cycling the power off and then on again.

Open a browser window and insert the following

URL: <http://192.168.88.89/admin>

The default user name / password is "admin" and "admin" (without the quotes). This can be renamed in the Change Password screen. At this point you will see the Configuration pages.

KWE P/N 394043 Versatronic 535 Solar Gateway V1.0 09/2013 Technical information subject to change without notice

Resol Deltasol M - BACNet/ IP

- Home
- BACnet/IP Settings**
- BACnet Device Settings
- Advanced Settings
- Restore Defaults
- Change Password
- Activate Configuration

BACnet/IP Settings

This page allows you to view current BACnet/IP settings, to change them or to restore them to factory defaults.

Parameter	Value	Description
IP	<input type="text" value="192.168.0.22"/>	IP address of the BACnet device.
Network Mask	<input type="text" value="255.255.255.0"/>	IP subnet mask.
Default Gateway	<input type="text" value="192.168.0.1"/>	IP address of the default gateway.
UDP Port	<input type="text" value="47808"/>	BACnet/IP UDP port number.

Copyright © 2006-2007 Cimetrics v1.2 (EX-28m-b7092-1.2)

IMPORTANT: Make sure that you remember any changes made here.

Configuration of Gateway Continued

BACnet Device Settings

You can now reconfigure these settings according to your network requirements. Make sure that you press SAVE on every screen where you make changes. The new setting will not take effect until the Activate Configuration screen has been confirmed. These configuration pages can now be accessed through both the 192.168.88.89 Address, as well as the one you have selected.

The BACnet Device Settings screen looks like this:

Resol Deltasol M - BACNet/ IP

- Home
- BACnet/IP Settings
- BACnet Device Settings**
- Advanced Settings
- Restore Defaults
- Change Password
- Activate Configuration

BACnet Device Settings

This page allows you to view current BACnet Device settings, to change them or to restore them to factory defaults.

Parameter	Value	Description
Device ID:	<input type="text" value="1"/>	BACnet Device Instance Number.
Object Name:	<input type="text"/>	Value of the Device's Object_Name property.
Description:	<input type="text"/>	Value of the Device's Device_Description property.
Location:	<input type="text"/>	Value of the Device's Device_Location property.

Copyright © 2006-2007 Cimetrics v1.2 (EX-28m-b7092-1.2)

NOTE: The **Device ID** must be unique on the entire BACnet internetwork.

The Restore Defaults and Change Password screens are very simplistic. When you select Activate Configuration, it will ask you if you want to SAVE your settings. This will then store your new settings and reboot automatically.

You can now join the Gateway to the rest of your network, provided you have not specified a duplicate IP Address. Any Computer on the network should now be able to access these configuration screens.

BACnet Objects

BACnet Objects

See following page for configuration notes

Object	Description	Units	Deltasol-M, Vitrosolic 200	SCU224, SCU124, Deltasol BS Plus	Deltasol 1/2/3/4	Deltasol-E	Deltasol-ES	Deltasol-BX Deltasol-BXL/SCU345	Deltasol-BX Plus	Deltasol-MX	Deltasol-SKSC3
Analog Output 1	Controls temperature units ¹	-	X	X	X	X	X	X	X	X	X
Analog Input 1	Temperature Sensor 1	C or F	X	X	X	X	X	X	X	X	X
Analog Input 2	Temperature Sensor 2	C or F	X	X	X	X	X	X	X	X	X
Analog Input 3	Temperature Sensor 3	C or F	X	X	X	X	X	X	X	X	X
Analog Input 4	Temperature Sensor 4	C or F	X	X	X	X	X	X	X	X	X
Analog Input 5	Temperature Sensor 5	C or F	X	-		X	X	X	X	X	X
Analog Input 6	Temperature Sensor 6	C or F	X	-		X	X		X	X	X
Analog Input 7	Temperature Sensor 7	C or F	X	-		X	X		X	X	X
Analog Input 8	Temperature Sensor 8	C or F	X	-		X	X		X	X	X
Analog Input 9	Temperature Sensor 9	C or F	X	-		X			X	X	
Analog Input 10	Temperature Sensor 10	C or F	X	-		X			X	X	
Analog Input 11	Temperature Sensor 11	C or F	X	-					X	X	
Analog Input 12	Temperature Sensor 12	C or F	X	-					X	X	
Analog Input 13	Irradiation	W/m ² , W/ft ²	X	-		X	X			X	X
Analog Input 14	Pulse Counter 1	-	X	-		X					
Analog Input 15	Pulse Counter 2	-	X	-							
Analog Input 16	Error mask sensor open ²	Binary	X	-							X
Analog Input 17	Error mask sensor short ²	Binary	X	-							X
Analog Input 18	Sensor mask ²	Binary	X	-		X					
Analog Input 19	Speed Relay 1	%	X	X	X	X	X	X	X	X	X
Analog Input 20	Speed Relay 2	%	X	X	X	X	X	X	X	X	X
Analog Input 21	Speed Relay 3	%	X	-		X	X	X	X	X	X
Analog Input 22	Speed Relay 4	%	X	-		X		X	X	X	X
Analog Input 23	Speed Relay 5	%	X	-		X			X	X	
Analog Input 24	Speed Relay 6	%	X	-		X				X	
Analog Input 25	Speed Relay 7	%	X	-		X				X	
Analog Input 26	Speed Relay 8	%	X	-						X	
Analog Input 27	Speed Relay 9	%	X	-						X	
Analog Input 28	Speed Relay 10	%	X	-						X	
Analog Input 29	Speed Relay 11	%	-	-				X ⁷		X	
Analog Input 30	Speed Relay 12	%	-	-				X ⁷		X	
Analog Input 31	Relay mask ²	Binary	X	X			X				
Analog Input 32	Error mask ²	Binary	X	X	X	X			X	X	X ⁶
Analog Input 33	Warning mask ²	Binary	X	-							
Analog Input 34	Option Mask / Schema	Binary or Dec.	-	X ³		X ⁵	X ³				
Analog Input 35	Heat Quantity in Wh ⁴	Wh	-	X	X		X	X			X
Analog Input 36	Heat Quantity in KWh ⁴	Wh	-	X	X		X	X			X
Analog Input 37	Heat Quantity in MWh ⁴	Wh	-	X	X		X	X			X
Analog Input 38	Operating Hours 1	Hours	-	X	X		X	X			
Analog Input 39	Operating Hours 2	Hours	-	X	X		X	X			

BACnet Objects

BACnet Objects Continued

See configuration notes below

Object	Description	Units	Deltasol-M, Vitosolic 200	SCU224, SCU124, Deltasol BS Plus	Deltasol 1/2/3/4	Deltasol-E	Deltasol-ES	Deltasol-BX Deltasol-BXL/SCU345	Deltasol-BX Plus	Deltasol-MX	Deltasol-SKSC3
Analog Input 40	Operating Hours 3	Hours					X	X			
Analog Input 41	Operating Hours 4	Hours					X	X			
Analog Input 42	Operating Hours 5	Hours					X	X			
Analog Input 43	Operating Hours 6	Hours					X				
Analog Input 44	Zone Supply 1	C or F				X					
Analog Input 45	Zone Supply 2	C or F				X					
Analog Input 46	Zone Supply 3	C or F				X					
Analog Input 47	Zone Supply 4	C or F				X					
Analog Input 48	Zone Status 1					X					
Analog Input 49	Zone Status 2					X					
Analog Input 50	Zone Status 3					X					
Analog Input 51	Zone Status 4					X					
Analog Input 52	Flow Volume (VFS Sensor)	l/h or gpm					X	X	X		X

BACnet Objects Configuration Notes

¹ 0 for Celsius, 1 for Fahrenheit

² Convert to binary

- Bit 0: Sensor/Relay 1 (least significant bit, furthest to the right)

- Bit 1: Sensor/Relay 2

Etc.

³ Convert to binary:

- Bit 0: Collector cooling, collector 1 (OCX)

- Bit 1: Minimum limitation, collector 1 (OCN)

- Bit 2: Antifreeze, collector 1 (OCF)

- Bit 3: Tube collector special function (OTC)

- Bit 4: Re-cooling function (OREC)

- Bit 5: Heat quantity measurement (OHQM)

⁴ Values roll over when reaching the next base-1000 magnitude (i.e. 999 Wh becomes 0 Wh + 1 kWh.)

⁵ System Arrangement

⁶ Convert to binary:

- Bit 0: Broken sensor

- Bit 1: Short circuit sensor

- Bit 2: DT high

- Bit 3: Warning circulation at night

⁷ Speed Pulse Width Modulation (PWM) 1,2

KWE P/N 394043 Versatronic 535 Solar Gateway V1.0 09/2013 Technical information subject to change without notice

Technical Information

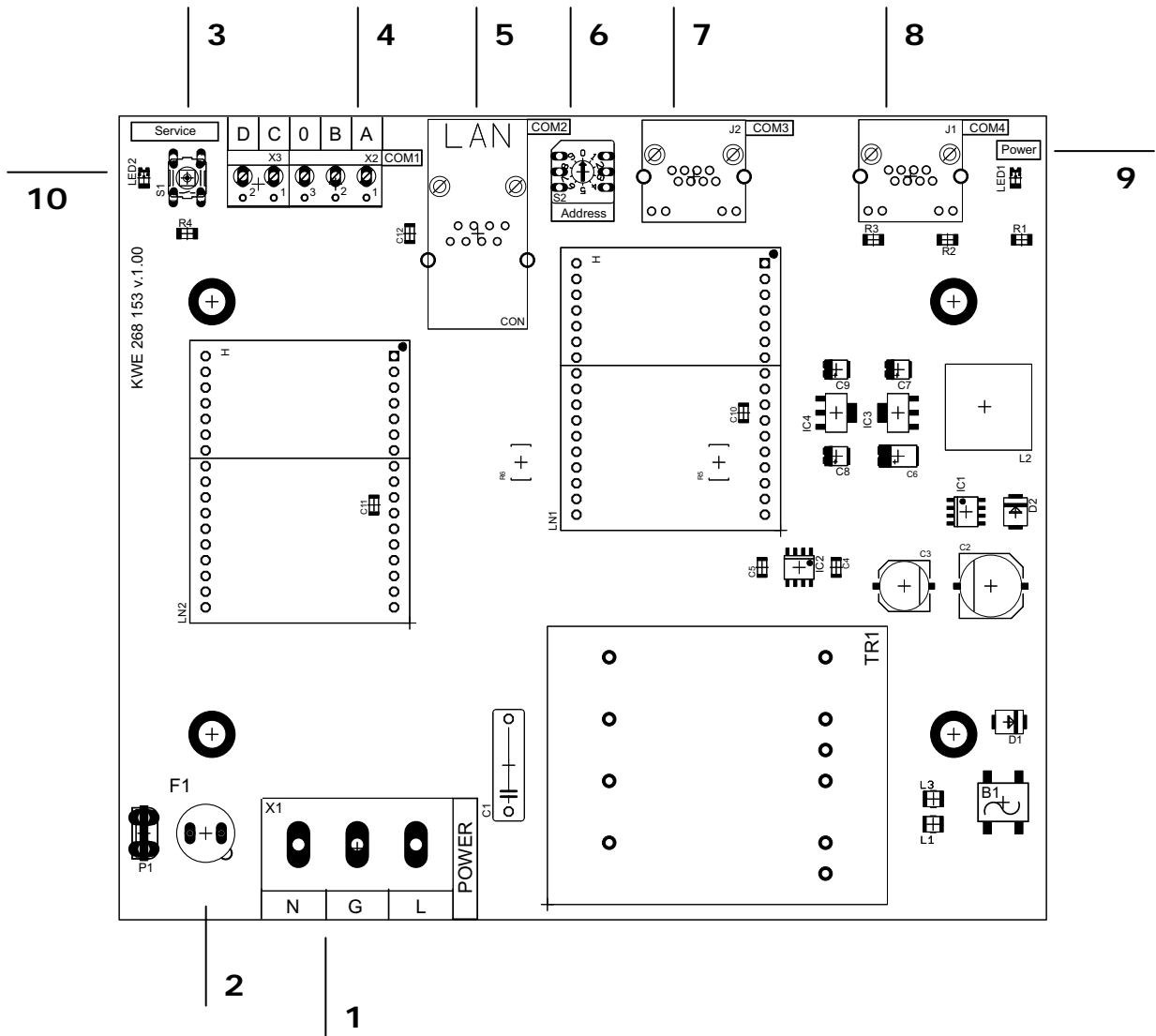

PCB Identifiers

1	120VAC Power Supply Connections
2	Fuse
3	Service Button
4	LON Connections to BMS
5	RJ45 Connection to BMS BACnet
6	Addressing selector for multiple modules
7	COM3 for multiple BUS connections
8	COM4 RJ45 Connection to control
9	Power LED indicator
10	Service LED

Specifications

Voltage Requirements	120VAC
Fuse Rating	160mA Time Delay
Power	4VA
Communication Connections	Supplied cable between devices

CAUTION

Static sensitive components may be damaged by improper handling or work within the control. Ensure all possible measures are taken to eliminate build-up of static electricity.

Technical Information

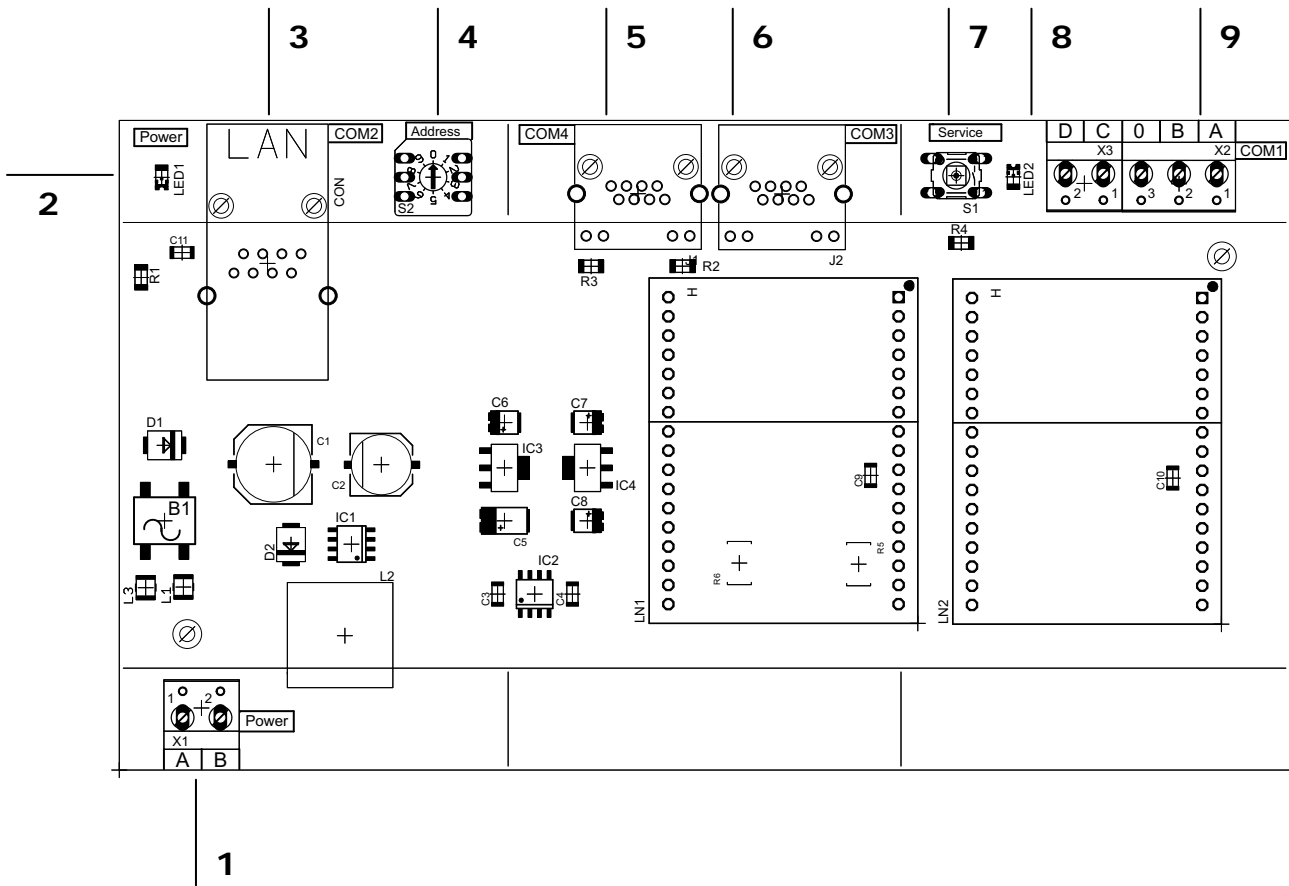

KWE P/N 394043 Versatronic 535 Solar Gateway V1.0 09/2013 Technical information subject to change without notice

PCB Identifiers

1	24VAC Power Supply Connections
2	Power LED indicator
3	BACnet RJ45 BMS Connection
4	Addressing dial for multiple units
5	COM4 RJ45 Connection to control
6	COM3 for multiple BUS connections
7	Service button
8	Service LED
9	LON Connections to BMS

Specifications

Voltage Requirements	24VAC
Fuse Rating	N/A
Power	4VA
Communication Connections	Supplied cable between devices



CAUTION

Static sensitive components may be damaged by improper handling or work within the control. Ensure all possible measures are taken to eliminate build-up of static electricity.

KWE Technologies Group
750 McMurray Road
Waterloo, Ontario, Canada
N2V 2G5
Tel: (519) 747-5042
Fax: (519) 747-4448
www.kwe-tech.com
info@kwe-tech.com

