

## Vitotronic 100, KW10A and KW10B Information Supplement

### For use with:

Viessmann Vitotronic 100, KW10A and B

### Overview:

KW10A Control Configurations

KW10A Configuration Checklist

KW10B Control Configurations

KW10B Configuration Checklist



---

## Technical and Configuration Information

---

### Cautionary Statement

The information presented in this document is only to be used by those familiar with its application and use.

This Information Supplement is to compliment the boiler control manual for the Vitotronic 100, KW10A and B control manual. It is not intended or to be regarded as a substitute for the CSA certified technical support literature that is supplied with each Vitotronic boiler control.



<b>IMPORTANT</b>
------------------

Read and save these instructions for future reference

## About these instructions



Take note of all symbols and notations intended to draw attention to potential hazards or important product information. These include "WARNING", "CAUTION" and "IMPORTANT". See below.

 <b>WARNING</b>
Indicates an imminently hazardous situation which, if not avoided, could result in death, serious injury or substantial product/property damage.

→ Warnings draw your attention to the presence of potential hazards or important product information.

 <b>CAUTION</b>
Indicates an imminently hazardous situation which, if not avoided, may result in minor injury or product/property damage.

→ Cautions draw your attention to the presence of potential hazards or important product information

 <b>CAUTION</b>
Static sensitive components may be damaged by improper handling or work within the control. Ensure all possible measures are taken to eliminate build-up of static electricity.

<b>IMPORTANT</b>
------------------

→ Helpful hints for installation, operation or maintenance which pertains to the product.

## Trademark Information

Viessmann® and Vitotronic® are trademarks of Viessmann Werke GmbH & Co KG registered in the United States and other countries.

Please visit:  
[www.viessmann.ca](http://www.viessmann.ca)  
[www.viessmann.us](http://www.viessmann.us)

Echelon®, LON®, LONWORKS®, i.LON®, LNS®, LONMARK®, Neuron®, and the LonUsers logo are trademarks of Echelon Corporation registered in the United States and other countries.

Please visit:  
[www.echelon.com](http://www.echelon.com)

## Important Regulatory and Installation Requirements

### Codes

The installation of this unit must be in accordance with local codes.

→ *Please carefully read this manual prior to attempting installation. Any warranty is null and void if these instructions are not followed.*

All electrical wiring is to be done in accordance with the latest edition of CSA C22,1 Part 1 and/or local codes. In the U.S. use the National Electrical Code ANSI/NFPA 70.

→ *The completeness and functionality of field supplied electrical controls and components must be verified by those installing the device*

The installing contractor must comply with the Standard of Controls and Safety Devices for Automatically fired Boilers, ANSI/ASME CSD-1 where required by the authority having jurisdiction.

### Working on the equipment

The installation, adjustment, service and maintenance of this unit must be done by a licensed professional heating contractor or persons who are qualified and experienced in the installation, service, and maintenance of similar products. There are no user serviceable parts on this control.

 <b>WARNING</b>
More than one live circuit. See wiring diagram in this manual. Turn off power supply to control and damper/blower before servicing. Contact with live electrical components can result in serious injury or death

### Power supply

Install power supply in accordance with the regulation of the authorities having jurisdiction or in absence of such requirements, in accordance with National Codes.

## Purpose of Device and Operation

Supplement Information to be used with control manual.

---

**Configurations**

TT Room Thermostat  
Internal Outdoor Reset  
Outdoor Reset with OT Enabled Stat  
0-10VDC Boiler Set Point Control  
Multi-Input Demands

---

**Configuration Checklist**

Field use form form

**System Description**

Room thermostat based call for heat. Two stage functionality if boiler is equipped for low fire and high fire operation.

If DHW operation required, connect supplied DHW sensor to control.

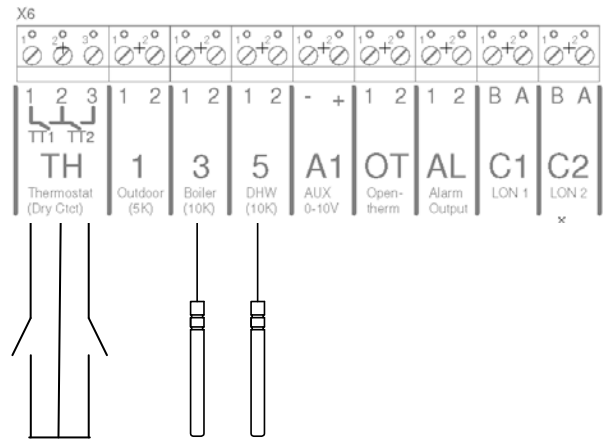
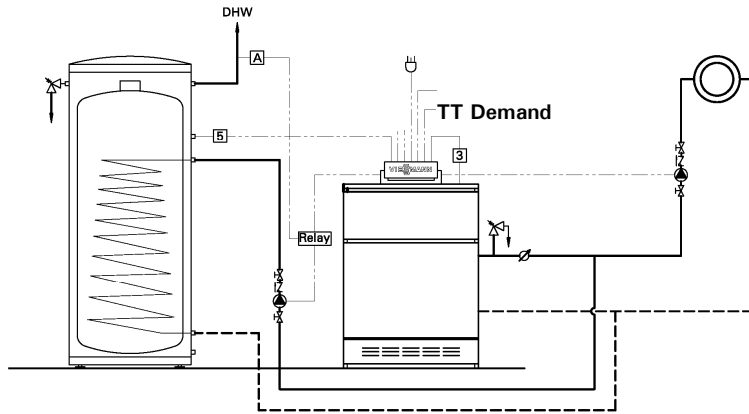

**Wiring Details—Low Voltage**

- Room thermostat connected to TH1 and 2 for 1st stage.
- Room thermostat connected to TH2 and 3 for 2nd stage.
- Boiler sensor connected to terminals at 3 boiler sensor section.
- DHW sensor connected to terminals at 5 DHW sensor section if required.

**Rotary Dial Settings**

	S1 Dial Setting	S2 Dial Setting	S3 Dial Setting	S4 Dial Setting	S5 Dial Setting
	LON Address Setting Leave at 0 unless required	Relay Test Leave in 0 Position unless required	DHW Set Point Adjust to desired setting	Slope Setting Leave at 0 for non-OTR	WWSO Setting Leave at 0 for non-OTR

**DIP Switch Settings S6 and S7**

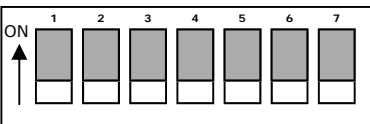

Position of DIP Switches when viewed from front of control

S6.1	S6.2	S6.3	S6.4	S6.5	S6.6	S6.7
Minimum Temp Boiler Function	Boiler Pump Post Purge	Boiler Pump Continuous Op.	Min Blr Pump Operation	OT Enabling	Internal Outdoor Reset Function	Auxiliary Contact Function
Boiler Dependant	User Selected	User Selected	User Selected	OFF	OFF	OFF

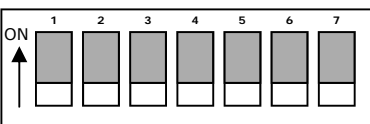

Position of DIP Switches when viewed from front of control

S7.1	S7.2	S7.3	S7.4	S7.5	S7.6	S7.7
DHW Priority	DHW Pump Post Purge	DHW Pump Post Purge Time	DHW Priority Override Timer	DHW Blr Temp Function	Blr Switching Differential	LON Card Function Enable
User Selected	User Selected	User Selected	User Selected	User Selected	User Selected	OFF

**System Description**

Internal outdoor reset functionality with 5K sensor connected to control. The S6.6 DIP switch is turned ON.

The Slope and WWSD settings are determined based on the information in the manual. If DHW operation required, connect supplied DHW sensor to control.

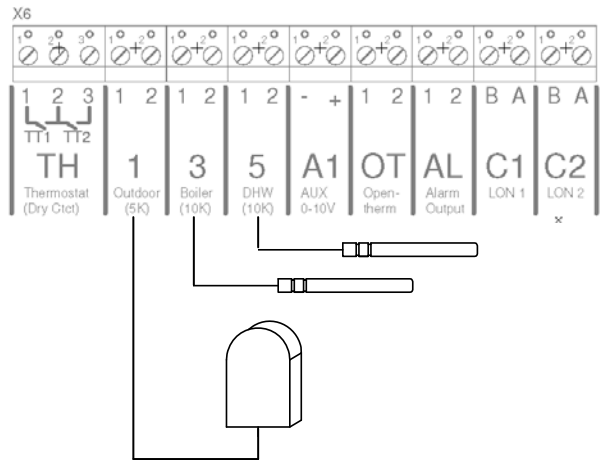
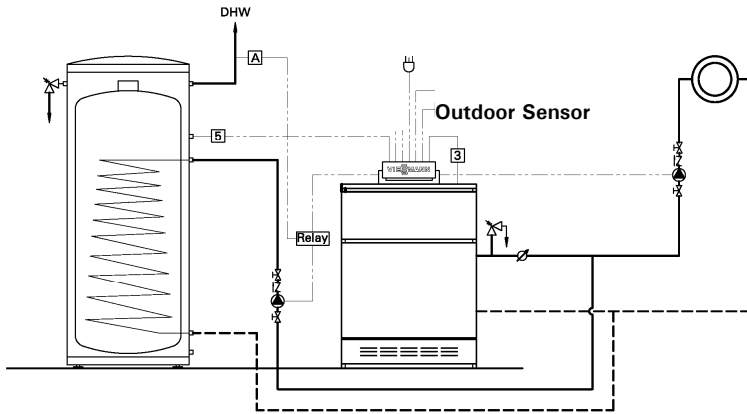

**Wiring Details—Low Voltage**

- Outdoor sensor connected to terminals at 1 outdoor sensor section.
- Boiler sensor connected to terminals at 3 boiler sensor section.
- DHW sensor connected to terminals at 5 DHW sensor section if required.

**Rotary Dial Settings**

S1 Dial Setting	S2 Dial Setting	S3 Dial Setting	S4 Dial Setting	S5 Dial Setting
LON Address Setting Leave at 0 unless required	Relay Test Leave in 0 Position unless required	DHW Set Point Adjust to desired setting	Slope Adjustment Minimum Setting 0.4	WWSD Adjustment Typical Dial Setting of 4

**DIP Switch Settings S6 and S7**

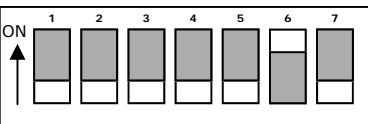

Position of DIP Switches when viewed from front of control

S6.1	S6.2	S6.3	S6.4	S6.5	S6.6	S6.7
Minimum Temp Boiler Function	Boiler Pump Post Purge	Boiler Pump Continuous Op.	Min Blr Pump Operation	OT Enabling	Internal Outdoor Reset Function	Auxiliary Contact Function
Boiler Dependant	User Selected	User Selected	User Selected	OFF	<b>ON</b>	OFF

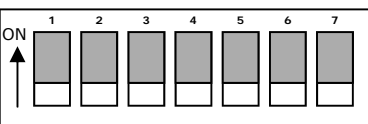

Position of DIP Switches when viewed from front of control

S7.1	S7.2	S7.3	S7.4	S7.5	S7.6	S7.7
DHW Priority	DHW Pump Post Purge	DHW Pump Post Purge Time	DHW Priority Override Timer	DHW Blr Temp Function	Blr Switching Differential	LON Card Function Enable
User Selected	User Selected	User Selected	User Selected	User Selected	User Selected	OFF

**System Description**

Internal outdoor reset functionality with 5K sensor connected to control. The S6.6 DIP switch is turned ON.

The Slope and WWSd settings are determined based on the information in the manual. If DHW operation required, connect supplied DHW sensor to control.

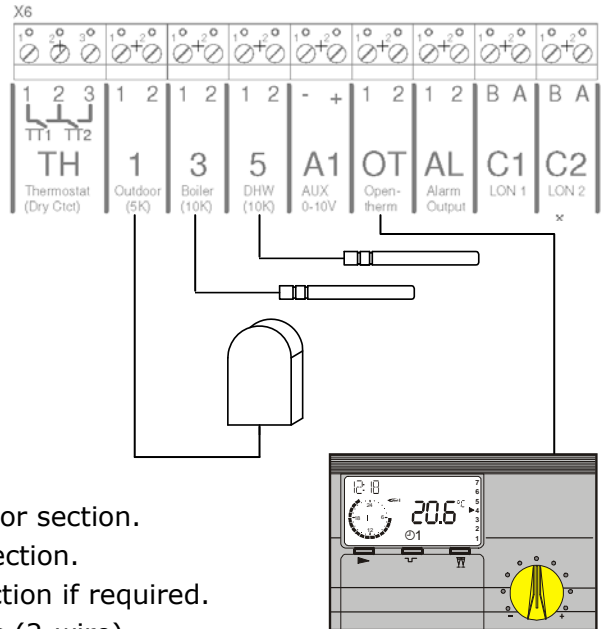
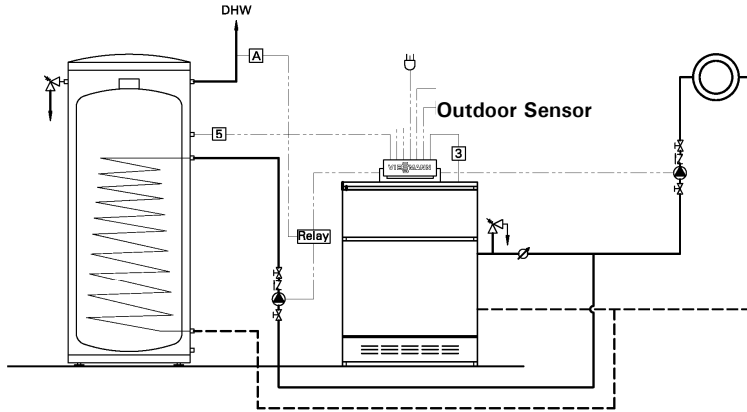

**Wiring Details—Low Voltage**

- Outdoor sensor connected to terminals at 1 outdoor sensor section.
- Boiler sensor connected to terminals at 3 boiler sensor section.
- DHW sensor connected to terminals at 5 DHW sensor section if required.
- Connection of OT enabled thermostat to the OT terminals (2-wire).

**Rotary Dial Settings**

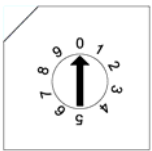

S1 Dial Setting	S2 Dial Setting	S3 Dial Setting	S4 Dial Setting	S5 Dial Setting
LON Address Setting Leave at 0 unless required	Relay Test Leave in 0 Position unless required	DHW Set Point Adjust to desired setting	N/A with OT enabled thermostat 0	N/A with OT enabled thermostat 0

**DIP Switch Settings S6 and S7**

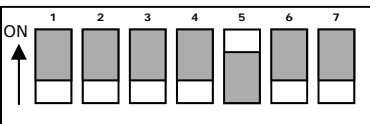

Position of DIP Switches when viewed from front of control

S6.1	S6.2	S6.3	S6.4	S6.5	S6.6	S6.7
Minimum Temp Boiler Function	Boiler Pump Post Purge	Boiler Pump Continuous Op.	Min Blr Pump Operation	OT Enabling	Internal Outdoor Reset Function	Auxiliary Contact Function
Boiler Dependant	User Selected	User Selected	User Selected	<b>ON</b>	OFF	OFF

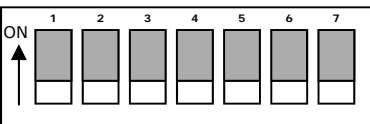

Position of DIP Switches when viewed from front of control

S7.1	S7.2	S7.3	S7.4	S7.5	S7.6	S7.7
DHW Priority	DHW Pump Post Purge	DHW Pump Post Purge Time	DHW Priority Override Timer	DHW Blr Temp Function	Blr Switching Differential	LON Card Function Enable
User Selected	User Selected	User Selected	User Selected	User Selected	User Selected	OFF

**System Description**

Boiler temperature set point is a function of the 0-10VDC reference signal. The incoming signal determines the boiler temperature set point. Should a higher boiler water temperature demand occur such as the DHW demand, the boiler will fire to achieve the new boiler temperature set point demand.

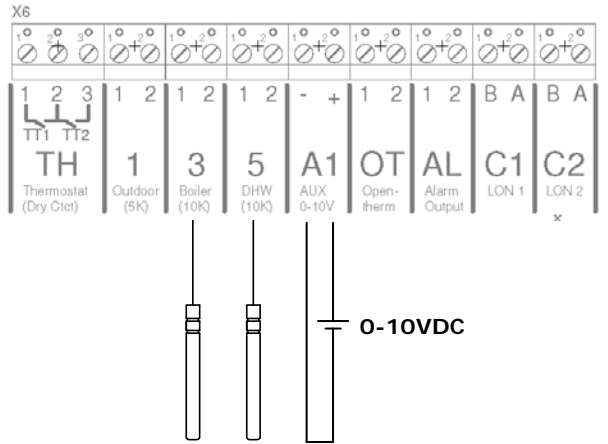
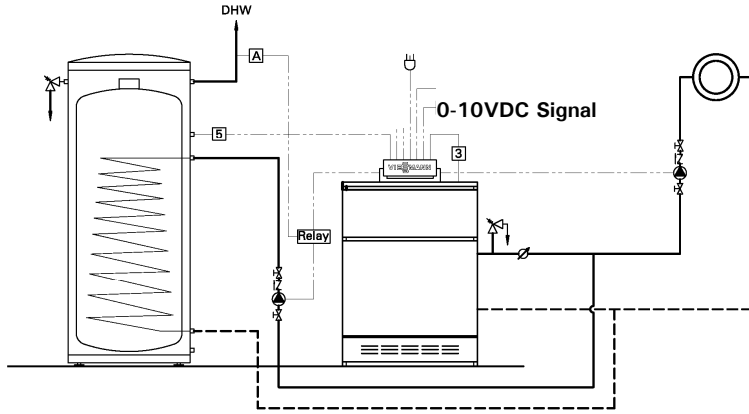

**Wiring Details—Low Voltage**

- Boiler sensor connected to terminals at 3 boiler sensor section.
- DHW sensor connected to terminals at 5 DHW sensor section if required.
- The 0-10VDC signal is terminated at the A1 + and – terminals. Signal range of 2-10VDC equates to 20C/68F to 100C/212F.

**Rotary Dial Settings**

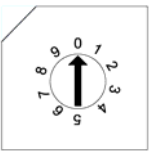

S1 Dial Setting	S2 Dial Setting	S3 Dial Setting	S4 Dial Setting	S5 Dial Setting
LON Address Setting Leave at 0 unless required	Relay Test Leave in 0 Position unless required	DHW Set Point Adjust to desired setting	N/A with OT enabled thermostat 0	N/A with OT enabled thermostat 0

**DIP Switch Settings S6 and S7**

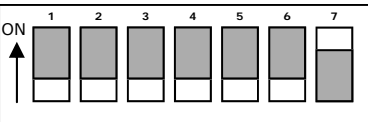

Position of DIP Switches when viewed from front of control

S6.1	S6.2	S6.3	S6.4	S6.5	S6.6	S6.7
Minimum Temp Boiler Function	Boiler Pump Post Purge	Boiler Pump Continuous Op.	Min Blr Pump Operation	OT Enabling	Internal Outdoor Reset Function	Auxiliary Contact Function
Boiler Dependant	User Selected	User Selected	User Selected	OFF	OFF	<b>ON</b>

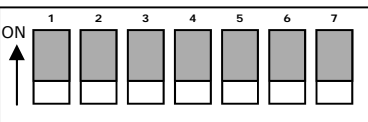

Position of DIP Switches when viewed from front of control

S7.1	S7.2	S7.3	S7.4	S7.5	S7.6	S7.7
DHW Priority	DHW Pump Post Purge	DHW Pump Post Purge Time	DHW Priority Override Timer	DHW Blr Temp Function	Blr Switching Differential	LON Card Function Enable
User Selected	User Selected	User Selected	User Selected	User Selected	User Selected	OFF



**System Description**

Heating system with multiple demands. Outdoor reset based operation with OT enabled thermostat. Auxiliary heat demand A1 connection for pool/spa heating demand. Room thermostat demands to enable boiler to fire above the outdoor reset set point for non-outdoor reset zones such as towel racks or occasional use basement zones.

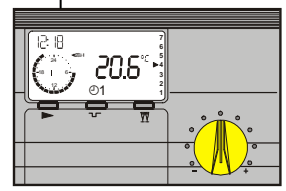
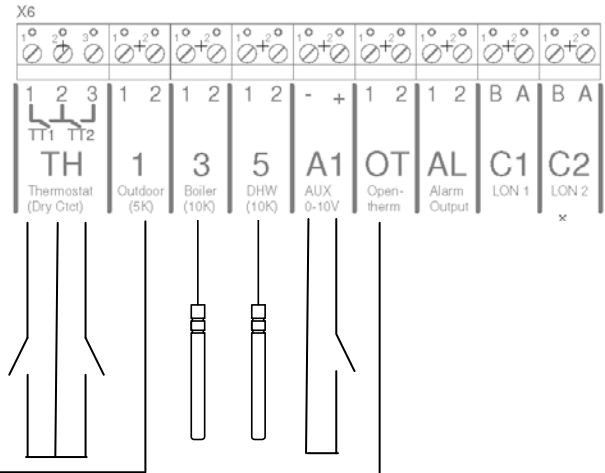
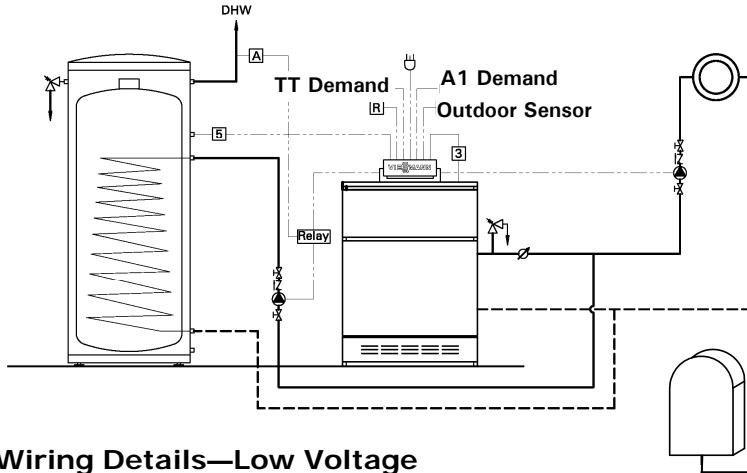

**Wiring Details—Low Voltage**

- Boiler sensor connected to terminals at 3 boiler sensor section.
- DHW sensor connected to terminals at 5 DHW sensor section if required.
- Room Thermostat connected to control for thermostat demand.
- Auxiliary Pool/Spa demand connected to A1 input.
- OT enabled thermostat such as the Como for outdoor reset operation.

**Rotary Dial Settings**

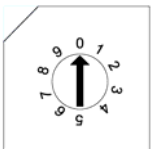

S1 Dial Setting	S2 Dial Setting	S3 Dial Setting	S4 Dial Setting	S5 Dial Setting
LON Address Setting Leave at 0 unless required	Relay Test Leave in 0 Position unless required	DHW Set Point Adjust to desired setting	N/A with OT enabled thermostat 0	N/A with OT enabled thermostat 0

**DIP Switch Settings S6 and S7**

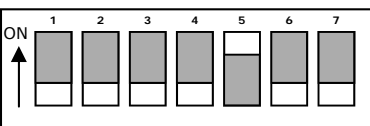

Position of DIP Switches when viewed from front of control

S6.1	S6.2	S6.3	S6.4	S6.5	S6.6	S6.7
Minimum Temp Boiler Function	Boiler Pump Post Purge	Boiler Pump Continuous Op.	Min Blr Pump Operation	OT Enabling	Internal Outdoor Reset Function	Auxiliary Contact Function
Boiler Dependant	User Selected	User Selected	User Selected	<b>ON</b>	OFF	OFF

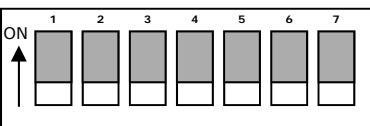

Position of DIP Switches when viewed from front of control

S7.1	S7.2	S7.3	S7.4	S7.5	S7.6	S7.7
DHW Priority	DHW Pump Post Purge	DHW Pump Post Purge Time	DHW Priority Override Timer	DHW Blr Temp Function	Blr Switching Differential	LON Card Function Enable
User Selected	User Selected	User Selected	User Selected	User Selected	User Selected	OFF

KWE P/N XXXXXX KW10A & B Information Supplement 06/2011 Technical information subject to change without notice

# KW10A Configuration Installation Checklist

## System Description

### Notes:

---



---



---



---



---



---



---

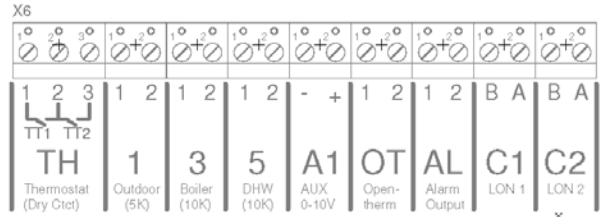
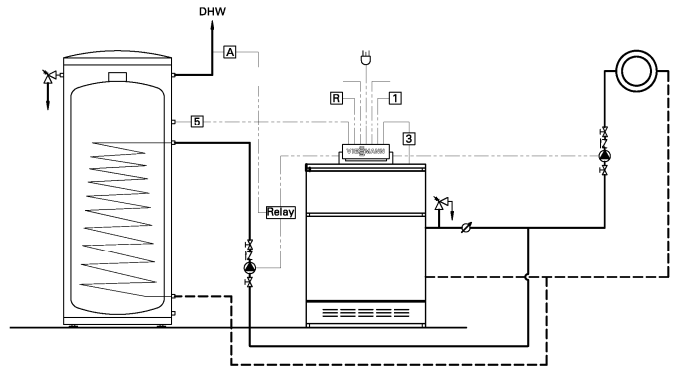

## Wiring Details—Low Voltage



### Notes:

---



---



---

## Rotary Dial Settings

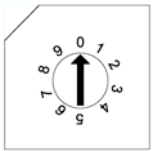

S1 Dial Setting	S2 Dial Setting	S3 Dial Setting	S4 Dial Setting	S5 Dial Setting

## DIP Switch Settings S6 and S7

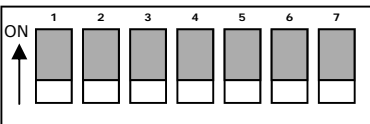

Position of DIP Switches when viewed from front of control

S6.1 Minimum Temp Boiler Function	S6.2 Boiler Pump Post Purge	S6.3 Boiler Pump Continuous Op.	S6.4 Min Blr Pump Operation	S6.5 OT Enabling	S6.6 Internal Outdoor Reset Function	S6.7 Auxiliary Contact Function

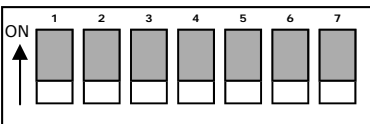

Position of DIP Switches when viewed from front of control

S7.1 DHW Priority	S7.2 DHW Pump Post Purge	S7.3 DHW Pump Post Purge Time	S7.4 DHW Priority Override Timer	S7.5 DHW Blr Temp Function	S7.6 Blr Switching Differential	S7.7 LON Card Function Enable

---

**Configurations**

- TT Room Thermostat
- Internal Outdoor Reset
- Outdoor Reset with OT Enabled Stat
- 0-10VDC Boiler Set Point Control
- Multi-Input Demands

---

**Configuration Checklist**

- Field use form form

**System Description**

Room thermostat based call for heat. Two stage functionality if boiler is equipped for low fire and high fire operation.

If DHW operation required, connect supplied DHW sensor to control.

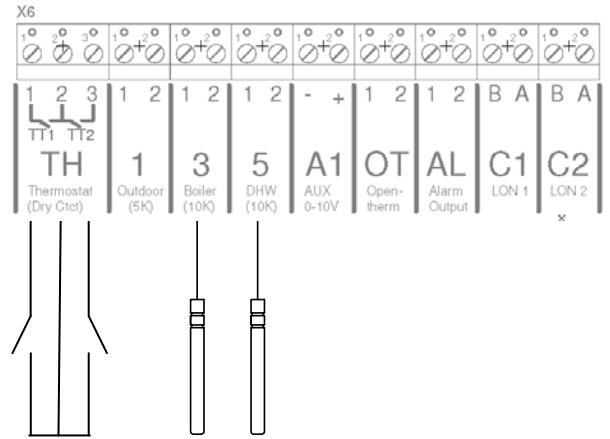
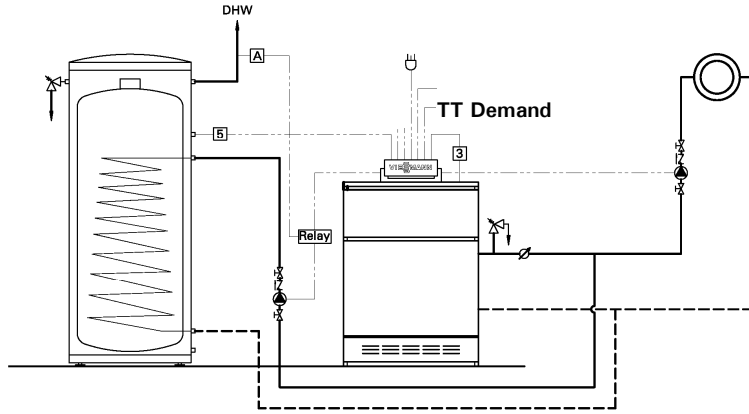

**Wiring Details—Low Voltage**

- Room thermostat connected to TH1 and 2 for 1st stage.
- Room thermostat connected to TH2 and 3 for 2nd stage.
- Boiler sensor connected to terminals at 3 boiler sensor section.
- DHW sensor connected to terminals at 5 DHW sensor section if required.

**Rotary Dial Settings**

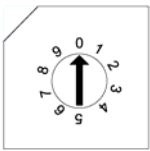

S1 Dial Setting	S2 Dial Setting	S3 Dial Setting	S4 Dial Setting	S5 Dial Setting
LON Address Setting Leave at 0 unless required	Relay Test Leave in 0 Position unless required	DHW Set Point Adjust to desired setting	Slope Setting Leave at 0 for non-OTR	WWSD Setting Leave at 0 for non-OTR

**DIP Switch Settings S6 and S7**

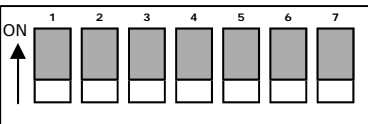

Position of DIP Switches when viewed from front of control

S6.1	S6.2	S6.3	S6.4	S6.5	S6.6	S6.7
Optional LON Card Function	Boiler Pump Post Purge	Boiler Pump Continuous Op.	Min Blr Pump Operation	OT Enabling	Internal Outdoor Reset Function	Auxiliary Contact Function
OFF	User Selected	User Selected	User Selected	OFF	OFF	OFF

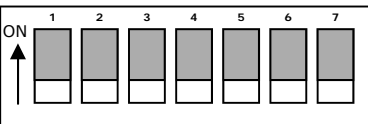

Position of DIP Switches when viewed from front of control

S7.1	S7.2	S7.3	S7.4	S7.5	S7.6	S7.7
DHW Priority	DHW Pump Post Purge	DHW Pump Post Purge Time	DHW Priority Override Timer	DHW Blr Temp Function	Min. Boiler Water Temp Function	Min. Boiler Water Temp Selection
User Selected	User Selected	User Selected	User Selected	User Selected	Boiler Specific	Boiler Specific

**System Description**

Internal outdoor reset functionality with 5K sensor connected to control. The S6.6 DIP switch is turned ON.

The Slope and WWSD settings are determined based on the information in the manual. If DHW operation required, connect supplied DHW sensor to control.

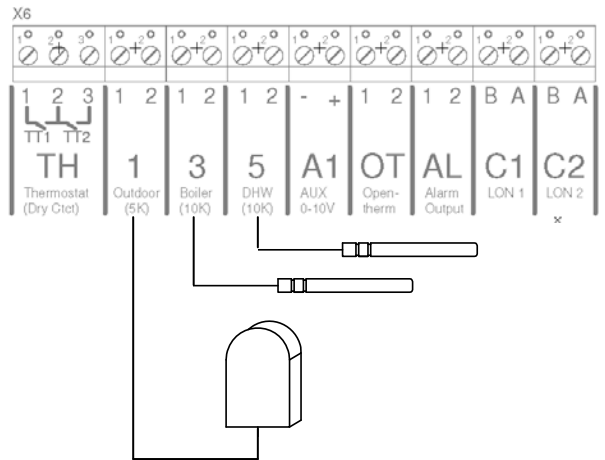
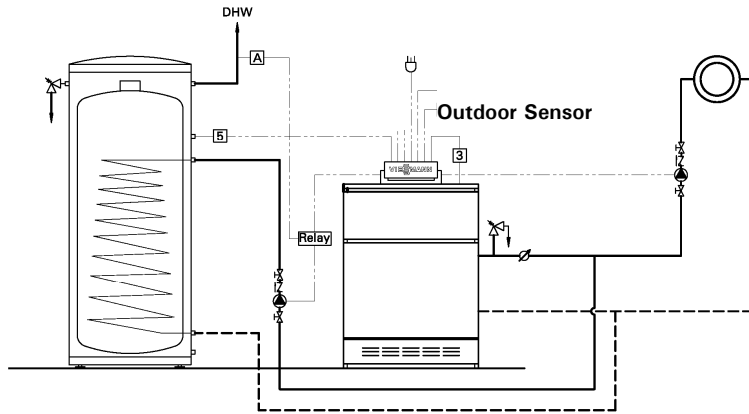

**Wiring Details—Low Voltage**

- Outdoor sensor connected to terminals at 1 outdoor sensor section.
- Boiler sensor connected to terminals at 3 boiler sensor section.
- DHW sensor connected to terminals at 5 DHW sensor section if required.

**Rotary Dial Settings**

	S1 Dial Setting	S2 Dial Setting	S3 Dial Setting	S4 Dial Setting	S5 Dial Setting
	LON Address Setting Leave at 0 unless required	Relay Test Leave in 0 Position unless required	DHW Set Point Adjust to desired setting	Slope Adjustment Minimum Setting 0.4	WWSD Adjustment Typical Dial Setting of 4

**DIP Switch Settings S6 and S7**

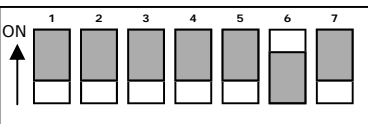

Position of DIP Switches when viewed from front of control

S6.1 Optional LON Card Function	S6.2 Boiler Pump Post Purge	S6.3 Boiler Pump Continuous Op.	S6.4 Min Blr Pump Operation	S6.5 OT Enabling	S6.6 Internal Outdoor Reset Function	S6.7 Auxiliary Contact Function
OFF	User Selected	User Selected	User Selected	OFF	<b>ON</b>	OFF

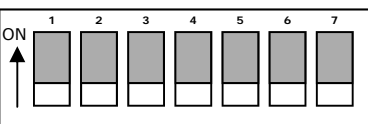

Position of DIP Switches when viewed from front of control

S7.1 DHW Priority	S7.2 DHW Pump Post Purge	S7.3 DHW Pump Post Purge Time	S7.4 DHW Priority Override Timer	S7.5 DHW Blr Temp Function	S7.6 Min. Boiler Water Temp Function	S7.7 Min. Boiler Water Temp Selection
User Selected	User Selected	User Selected	User Selected	User Selected	Boiler Specific	Boiler Specific

**System Description**

Internal outdoor reset functionality with 5K sensor connected to control. The S6.6 DIP switch is turned ON.

The Slope and WWSd settings are determined based on the information in the manual. If DHW operation required, connect supplied DHW sensor to control.

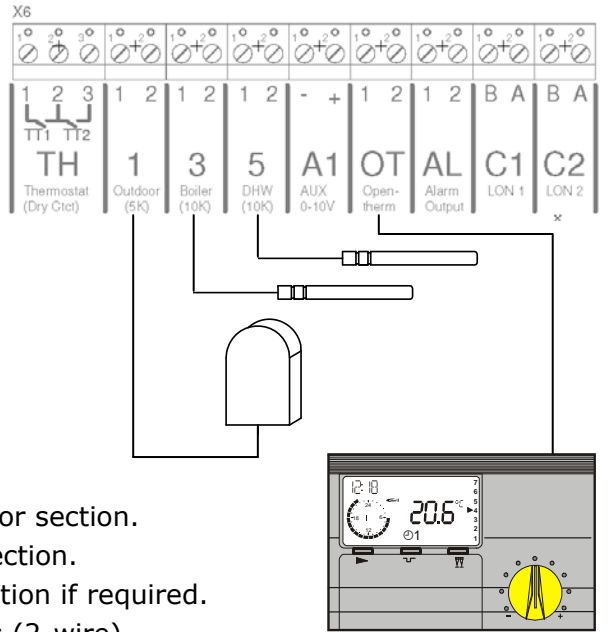
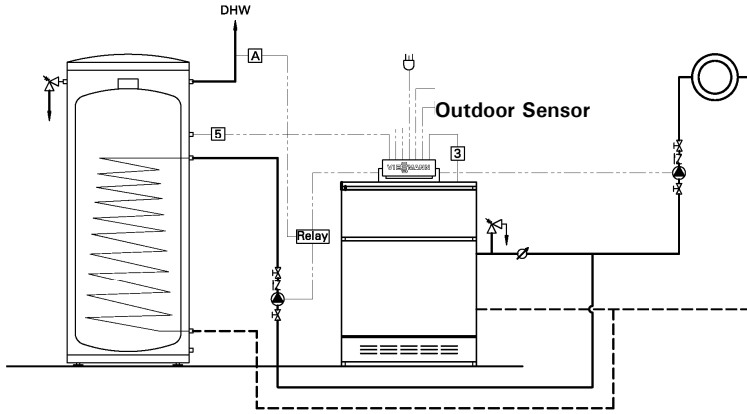

**Wiring Details—Low Voltage**

- Outdoor sensor connected to terminals at 1 outdoor sensor section.
- Boiler sensor connected to terminals at 3 boiler sensor section.
- DHW sensor connected to terminals at 5 DHW sensor section if required.
- Connection of OT enabled thermostat to the OT terminals (2-wire).

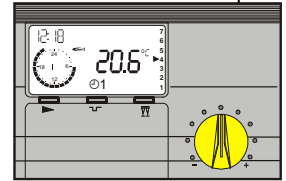

**Rotary Dial Settings**

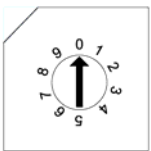

S1 Dial Setting	S2 Dial Setting	S3 Dial Setting	S4 Dial Setting	S5 Dial Setting
LON Address Setting Leave at 0 unless required	Relay Test Leave in 0 Position unless required	DHW Set Point Adjust to desired setting	N/A with OT enabled thermostat 0	N/A with OT enabled thermostat 0

**DIP Switch Settings S6 and S7**

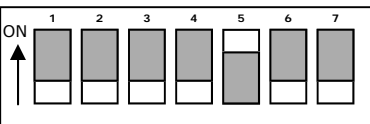

Position of DIP Switches when viewed from front of control

S6.1	S6.2	S6.3	S6.4	S6.5	S6.6	S6.7
Optional LON Card Function	Boiler Pump Post Purge	Boiler Pump Continuous Op.	Min Blr Pump Operation	OT Enabling	Internal Outdoor Reset Function	Auxiliary Contact Function
OFF	User Selected	User Selected	User Selected	<b>ON</b>	OFF	OFF

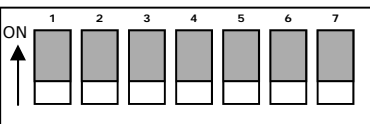

Position of DIP Switches when viewed from front of control

S7.1	S7.2	S7.3	S7.4	S7.5	S7.6	S7.7
DHW Priority	DHW Pump Post Purge	DHW Pump Post Purge Time	DHW Priority Override Timer	DHW Blr Temp Function	Min. Boiler Water Temp Function	Min. Boiler Water Temp Selection
User Selected	User Selected	User Selected	User Selected	User Selected	Boiler Specific	Boiler Specific

**System Description**

Boiler temperature set point is a function of the 0-10VDC reference signal. The incoming signal determines the boiler temperature set point. Should a higher boiler water temperature demand

occur such as the DHW demand, the boiler will fire to achieve the new boiler temperature set point demand.

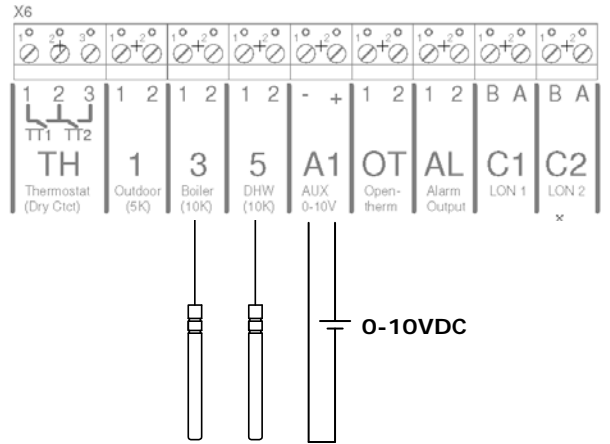
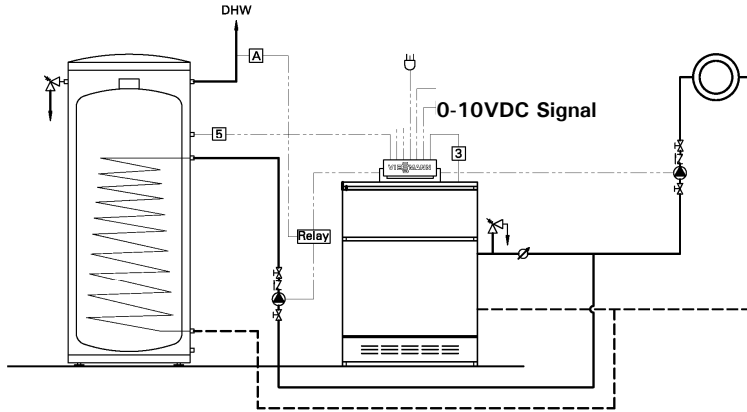

**Wiring Details—Low Voltage**

- Boiler sensor connected to terminals at 3 boiler sensor section.
- DHW sensor connected to terminals at 5 DHW sensor section if required.
- The 0-10VDC signal is terminated at the A1 + and – terminals. Signal range of 2-10VDC equates to 20C/68F to 100C/212F.

**Rotary Dial Settings**

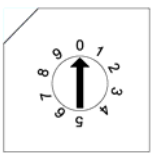

S1 Dial Setting	S2 Dial Setting	S3 Dial Setting	S4 Dial Setting	S5 Dial Setting
LON Address Setting Leave at 0 unless required	Relay Test Leave in 0 Position unless required	DHW Set Point Adjust to desired setting	N/A with OT enabled thermostat 0	N/A with OT enabled thermostat 0

**DIP Switch Settings S6 and S7**

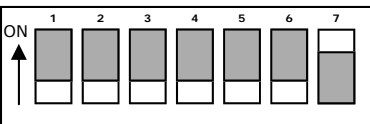

Position of DIP Switches when viewed from front of control

S6.1	S6.2	S6.3	S6.4	S6.5	S6.6	S6.7
Optional LON Card Function	Boiler Pump Post Purge	Boiler Pump Continuous Op.	Min Blr Pump Operation	OT Enabling	Internal Outdoor Reset Function	Auxiliary Contact Function
OFF	User Selected	User Selected	User Selected	OFF	OFF	<b>ON</b>

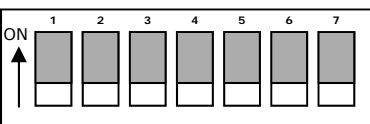

Position of DIP Switches when viewed from front of control

S7.1	S7.2	S7.3	S7.4	S7.5	S7.6	S7.7
DHW Priority	DHW Pump Post Purge	DHW Pump Post Purge Time	DHW Priority Override Timer	DHW Blr Temp Function	Min. Boiler Water Temp Function	Min. Boiler Water Temp Selection
User Selected	User Selected	User Selected	User Selected	User Selected	Boiler Specific	Boiler Specific

**System Description**

Heating system with multiple demands. Outdoor reset based operation with OT enabled thermostat. Auxiliary heat demand A1 connection for pool/spa heating demand. Room thermostat demands to enable boiler to fire above the outdoor reset set point for non-outdoor reset zones such as towel racks or occasional use basement zones.

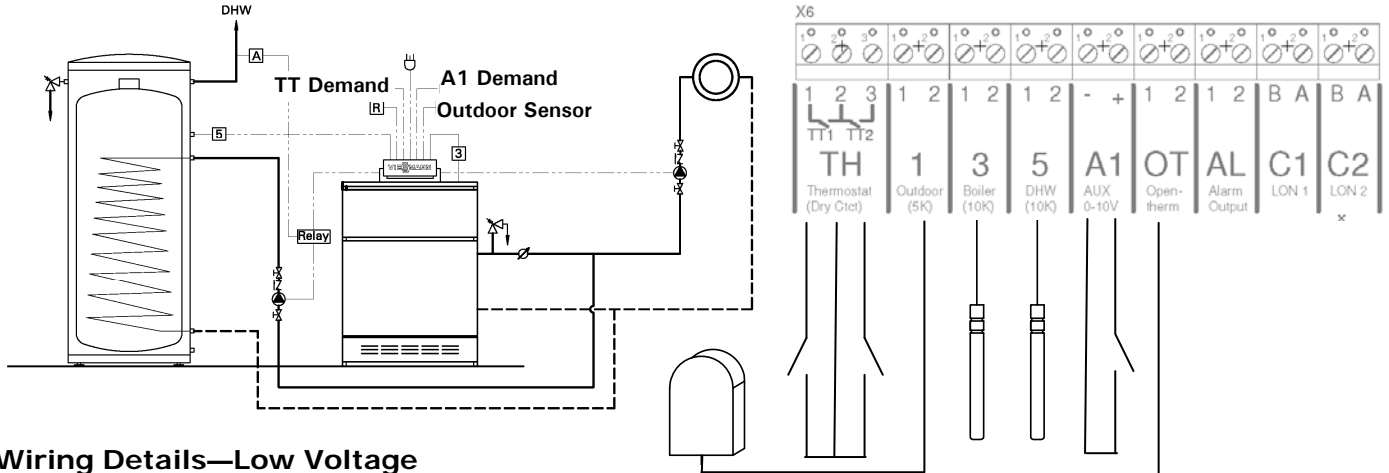

**Wiring Details—Low Voltage**

- Boiler sensor connected to terminals at 3 boiler sensor section.
- DHW sensor connected to terminals at 5 DHW sensor section if required.
- Room Thermostat connected to control for thermostat demand.
- Auxiliary Pool/Spa demand connected to A1 input.
- OT enabled thermostat such as the Como for outdoor reset operation.

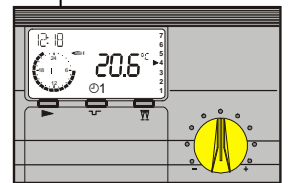

**Rotary Dial Settings**

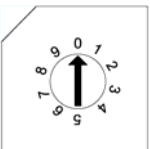

S1 Dial Setting	S2 Dial Setting	S3 Dial Setting	S4 Dial Setting	S5 Dial Setting
LON Address Setting Leave at 0 unless required	Relay Test Leave in 0 Position unless required	DHW Set Point Adjust to desired setting	N/A with OT enabled thermostat 0	N/A with OT enabled thermostat 0

**DIP Switch Settings S6 and S7**

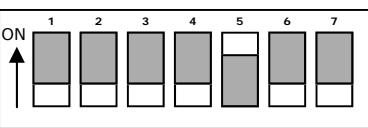

Position of DIP Switches when viewed from front of control

S6.1	S6.2	S6.3	S6.4	S6.5	S6.6	S6.7
Optional LON Card Function	Boiler Pump Post Purge	Boiler Pump Continuous Op.	Min Blr Pump Operation	OT Enabling	Internal Outdoor Reset Function	Auxiliary Contact Function
OFF	User Selected	User Selected	User Selected	<b>ON</b>	OFF	OFF

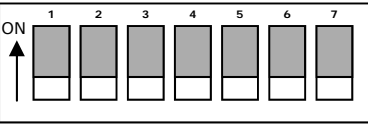

Position of DIP Switches when viewed from front of control

S7.1	S7.2	S7.3	S7.4	S7.5	S7.6	S7.7
DHW Priority	DHW Pump Post Purge	DHW Pump Post Purge Time	DHW Priority Override Timer	DHW Blr Temp Function	Min. Boiler Water Temp Function	Min. Boiler Water Temp Selection
User Selected	User Selected	User Selected	User Selected	User Selected	Boiler Specific	Boiler Specific



# KW10B Configuration Installation Checklist

## System Description

### Notes:

---



---



---



---



---



---



---

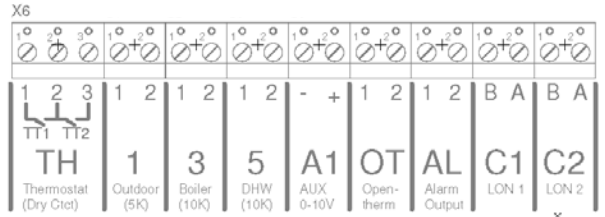
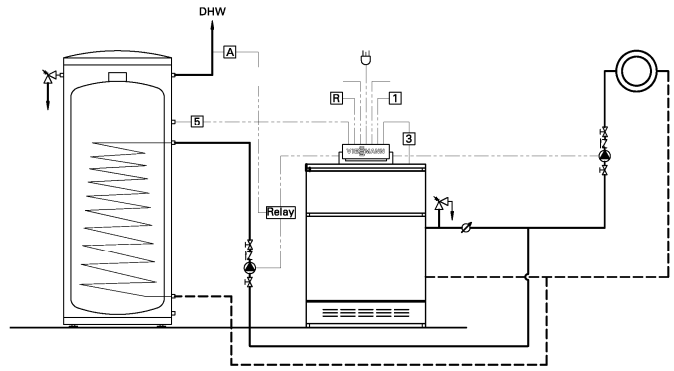

## Wiring Details—Low Voltage



### Notes:

---



---



---



---

## Rotary Dial Settings

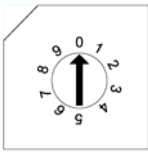

S1 Dial Setting	S2 Dial Setting	S3 Dial Setting	S4 Dial Setting	S5 Dial Setting

## DIP Switch Settings S6 and S7

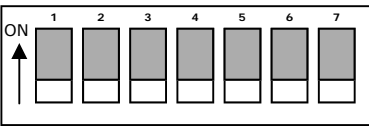

Position of DIP Switches when viewed from front of control

S6.1 Optional LON Card Function	S6.2 Boiler Pump Post Purge	S6.3 Boiler Pump Continuous Op.	S6.4 Min Blr Pump Operation	S6.5 OT Enabling	S6.6 Internal Outdoor Reset Function	S6.7 Auxiliary Contact Function

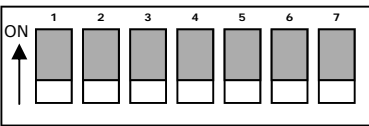

Position of DIP Switches when viewed from front of control

S7.1 DHW Priority	S7.2 DHW Pump Post Purge	S7.3 DHW Pump Post Purge Time	S7.4 DHW Priority Override Timer	S7.5 DHW Blr Temp Function	S7.6 Min. Boiler Water Temp Function	S7.7 Min. Boiler Water Temp Selection

KWE P/N XXXXXX KW10A & B Information Supplement 06/2011 Technical information subject to change without notice

KWE Technologies Group  
750 McMurray Road  
Waterloo, Ontario, Canada  
N2V 2G5  
Tel: (519) 747-5042  
Fax: (519) 747-4448  
[www.kwe-tech.com](http://www.kwe-tech.com)  
[info@kwe-tech.com](mailto:info@kwe-tech.com)

